



# ENR-1000 Series

## System Administrator's Manual

For V4.02.09 Firmware

ENR-1000

ENR-1100

ENR-1200

# Legal Notice

## Disclaimer

---

- The information contained in this document is intended for general information purposes. ACTi Corporation shall not be liable for errors contained herein or for incidental or consequential damages arising from the furnishing, performance, or use of this manual.
- The information contained herein is subject to change without notice.
- The English version of this document is the official one for all purpose. All the translated versions are provided as a convenience. Any discrepancies or differences created in the translations of any other languages are not legally binding.

## Copyright

---

Copyright ©2013-2014 ACTi Corporation All Rights Reserved.

## Trademarks

---

- ACTi Connecting Vision and its logo  **ACTi**  
Connecting Vision are registered trademarks of ACTi Corporation.
- Microsoft® and Windows® are registered trademarks of Microsoft Corporation.  
All other product or company names mentioned in this document may be trademarks or registered trademarks of their respective owners.

## Regulatory Compliance Information

---

### Federal Communications Commission Statement



This equipment has been tested and found to comply with the limits for a Class B digital device, pursuant to Part 15 of the FCC Rules. These limits are designed to provide reasonable protection against harmful interference in a residential installation. This equipment generates, uses and can radiate radio frequency energy and, if not installed and used in accordance with the instructions, may cause harmful interference to radio communications. However, there is no guarantee that interference will not occur in a particular installation. If this equipment does cause harmful interference to radio or television reception, which can be determined by turning the equipment off and on, the user is encouraged to try to correct the interference by one or more of the following measures:

- Reorient or relocate the receiving antenna.
- Increase the separation between the equipment and receiver.
- Connect the equipment into an outlet on a circuit different from that to which the receiver is connected.
- Consult the dealer or an experienced radio/TV technician for help.

**WARNING:** Changes or modifications to the equipment that are not expressly approved by the responsible party for compliance could void the user's authority to operate the equipment.

### European Community Compliance Statement



This product has been tested and found to comply with the limits for Class B Information Technology Equipment according to European Standard EN 55022 and EN 55024. In a domestic environment, this product may cause radio interference in which cause the user be require to take adequate measures.

# About This Manual

## Target Audience

---

This manual is intended for **System Administrators** who are responsible for installing and setting up video surveillance system. The reader is expected to know the fundamentals of IP surveillance system integration and to own the administrative privileges to install and configure all the devices.

You may also visit **ACTi Download Center** for updates and documents:

<http://www.acti.com/DownloadCenter>

## Technical Support

---

If you have any questions during system installation, please feel free to contact our engineers via our **Customer Help Desk** platform <http://www.acti.com/CHD>.



# Table of Contents

## **1 Legal Notice 2**

---

Disclaimer	2
Copyright	2
Trademarks .....	2
Regulatory Compliance Information.....	3

## **2 About This Manual 4**

---

Target Audience .....	4
Technical Support.....	4

## **3 Table of Contents 5**

## **4 Introduction 11**

---

Product Overview .....	11
ENR Server / Client Architecture.....	11
Remote Client PC Requirements .....	12
Video Display Performance .....	13
Local Live View / Playback .....	13
Remote Live View.....	14
Remote Playback .....	14
Supported Video Format.....	15

## **5 Get Started 16**

---

What's in the Box.....	16
At A Glance.....	17
Front Panel .....	17
Rear Panel.....	17
Power Button & Reset Button .....	18
Turn on the Unit.....	18

Turn off the Unit .....	18
Reset to Factory Default .....	19
<b>LED Indicators .....</b>	<b>19</b>

## **6 Installation 20**

---

<b>Prepare the Devices .....</b>	<b>20</b>
Cameras .....	20
Monitor .....	21
USB Devices .....	21
USB Storage Device .....	21
Hard Disks .....	21
<b>Install the Hard Disks .....</b>	<b>22</b>
Step 1 Remove the Case Cover .....	22
Step 2 Install Disk SATA-2 .....	22
Step 3 Install Disk SATA-1 .....	23
Step 4 Install the Case Cover Back .....	23
<b>Network Connection Architecture .....</b>	<b>24</b>
LAN 1 Port .....	24
Connection Setting Example 1 .....	24
LAN 2 Port .....	25
Connection Setting Example 2 .....	25
<b>Connect the Devices .....</b>	<b>26</b>
<b>Quick Setup .....</b>	<b>27</b>
Step 1: Log in to ENR .....	27
Step 2: Format the Hard Disks .....	28
Step 3: Add Cameras .....	28
Auto Add .....	29
Search Cameras .....	29

## **7 Local Client Operation 31**

---

<b>Log in to / out of ENR .....</b>	<b>31</b>
Log In .....	31
Change UI language .....	31
Remember Login Information .....	31
Set Auto Login .....	31
<b>Live Page UI Overview .....</b>	<b>32</b>

<b>Input Devices .....</b>	<b>33</b>
Onscreen Keyboard.....	33
Mouse Settings.....	34
Onscreen Keyboard Settings.....	34
<b>Set Cameras .....</b>	<b>35</b>
Other cameras .....	36
Add Cameras.....	37
Add Cameras Manually .....	38
Add Cameras Manually (ONVIF) .....	39
Add Cameras Manually (RTSP) .....	40
Copy Camera Settings .....	41
Delete Cameras.....	42
Change Camera Settings .....	43
(A) Video Format and Transmission Properties .....	43
(B) Motion Settings .....	44
(C) Fine-tune the Image: Brightness/Contrast/Saturation/Hue .....	45
Configure PTZ Devices .....	46
Open PTZ Panel.....	48
Manipulate PTZ Movements .....	48
Go to Preset Points .....	49
Edit PTZ Preset Tour .....	50
<b>Device Information .....</b>	<b>51</b>
<b>Network Settings .....</b>	<b>52</b>
IP Settings .....	53
Change Port Setting .....	54
Enable DHCP Server .....	55
Enable DDNS Service .....	56
<b>Date &amp; Time.....</b>	<b>57</b>
Setup Manually.....	57
Synchronize with Time Zone .....	57
<b>E-mail Settings.....</b>	<b>58</b>
<b>Disk Management .....</b>	<b>60</b>
Storage Device Types .....	60
Format Hard Disks.....	61
Storage Settings - Set Recording Deletion Rule .....	61
Check Disk Status .....	62
Manage Abnormal Disks.....	63
<b>Schedule Recordings.....</b>	<b>64</b>
Event-Recording File Length.....	65

Set the Recording Schedule.....	65
Set the Event Schedule.....	66
Copy Schedule.....	66
<b>Event Management.....</b>	<b>67</b>
Event-Handling Schedule.....	67
Set System Event Rules.....	68
Set Device Event Rules.....	68
Trigger Type.....	69
Clear Event Rules.....	71
Copy Event Rules.....	72
<b>Joystick.....</b>	<b>73</b>
<b>System Log.....</b>	<b>74</b>
Export System Log.....	75
<b>User Group Management.....</b>	<b>76</b>
Add a Group.....	76
Edit / Delete a Group.....	77
Add a User.....	77
Edit / Delete a User.....	78
<b>Upgrade Firmware.....</b>	<b>79</b>
<b>Backup / Restore Settings.....</b>	<b>80</b>
Backup.....	80
Restore.....	81
<b>Customize Live Screen Layout.....</b>	<b>82</b>
Change Channel Position.....	82
Change Layout.....	82
Execute Sequence Patrol.....	84
Save a Customized View.....	84
Set a Default View.....	84
<b>Customize System Language.....</b>	<b>85</b>
Modify the Wording.....	85
Restore the Wording.....	86

## **8 Remote Client Operation 87**

<b>Access ENR Server.....</b>	<b>87</b>
Find ENR in Your Network.....	87
Via UPnP Connection.....	88
Via ACTi IP Utility.....	89
<b>Log In / Out.....</b>	<b>90</b>

Log In.....	90
Enter Account & Password	90
Change UI language	90
Remember Login Information	90
Log Out.....	90
Accept ActiveX Controls Installation .....	91
<b>Setup Wizard .....</b>	<b>92</b>
<b>Setup the System .....</b>	<b>93</b>
Set System Name.....	93
Set Date & Time .....	94
Change Time Zone	94
Change Date and Time	94
Set Daylight Saving	94
Set NTP Server	94
Synchronize with Client Computer's Time	95
Configure Network Settings.....	96
Current IP Configurations	96
IP Settings	96
Enable DHCP Server	97
Set HTTP Port	98
Enable DDNS Service	98
Set E-mail Notification Service .....	100
Live Screen Event List Setting .....	101
<b>Live Page UI Overview .....</b>	<b>102</b>
<b>Set Cameras .....</b>	<b>104</b>
Add Cameras.....	104
Copy Camera Settings .....	109
Delete Cameras.....	110
Change Camera Settings .....	110
(A) Video Format and Transmission Properties	110
(B) Motion Settings	111
(C) Fine-tune the Image: Brightness/Contrast/Saturation/Hue	112
Configure PTZ Preset Points	114
Configure PTZ Preset Tour	116
Configure Fisheye Cameras.....	117
<b>Set Recording Schedule .....</b>	<b>120</b>
Event-Recording File Length.....	120
Set the Recording Schedule.....	121
Set the Event Handling Schedule.....	121

Copy Schedule .....	122
<b>Event Management .....</b>	<b>123</b>
Set Event Rules .....	123
Set System Event rule .....	123
Set Camera Event rule .....	124
Response Types .....	126
Copy Event Rules .....	128
Clear Event Rules .....	129
<b>Disk Management .....</b>	<b>130</b>
Format Hard Disks .....	130
Set Maximum Recording Days .....	131
Check Disk Status .....	131
<b>Upgrade Firmware .....</b>	<b>132</b>
<b>Backup / Restore Settings .....</b>	<b>133</b>
Backup .....	133
Restore .....	134
<b>User Group Management .....</b>	<b>135</b>
Add a Group .....	135
Edit / Delete a Group .....	136
Add a User .....	137
Account /Password Rules .....	137
Edit / Delete a User .....	137
<b>Joystick .....</b>	<b>138</b>
<b>System Log .....</b>	<b>139</b>
Export System Log .....	140
<b>Customize Live Screen Layout .....</b>	<b>141</b>
Add Camera Views to Channels .....	141
Remove Camera Views .....	141
Execute Sequence Patrol .....	142
Save a Customized View .....	142
Set a Default View .....	142

# Introduction

## Product Overview

---

**ACTi ENR-1000 Series** (hereafter referred to as **ENR**) is a compact and reliable multi-channel standalone NVR. It features a stable embedded Linux operating system and capabilities of supporting mega-pixel resolution H.264 streaming, an HDMI output for local display, PTZ control, scheduled / event-triggered / event speed-up recording, event management, synchronized playback, time / event-based playback search and video bookmarks. Its smart Setup Wizard and intuitive user interface allow the system installer to enjoy effortless installation experience, while making it easy for new users to get acquainted with the operation by first-time use. Other than the local client, the remote PC client may access the ENR system simultaneously, and experience user-friendly web interface customized for browser-based operations.

## ENR Server / Client Architecture

---

In a video surveillance system architecture, **ENR** serves as service provider, aimed to run 24/7 non-stop a video management service for clients. An **ENR Client** makes requests for monitoring video streams or playing back recordings of **ENR**.

There are two types of **ENR** clients: **Local Client** and **Remote Client**. A client, connecting from whether a remote computer or from local, will be offered the same functionalities of **ENR**.

- **Local Client**: In the local site, the client user directly operates **ENR** by connecting an HDMI monitor and a USB mouse to the physical **ENR**.
- **Remote Client**: Over the TCP/IP network, the **Remote Client** communicates with **ENR** through HTTP Protocol. This client user will have to use a computer with Internet Explorer to access the **ENR** web interface, without the need of installing any client program beforehand. Logging in to **ENR** is as simple as visiting a website.

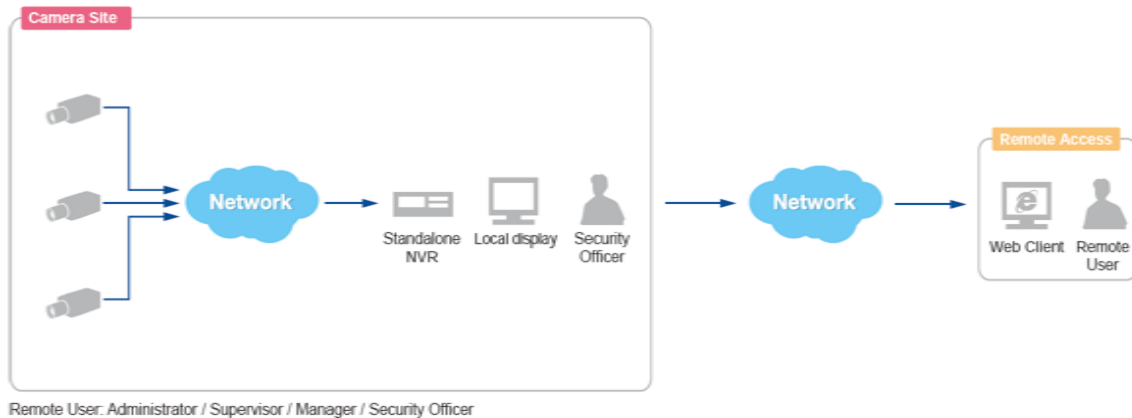

## Remote Client PC Requirements

As ENR itself is a self-contained unit, the table below provides basic guidelines only for selecting proper hardware for the remote PC client. If your live view display quality is not satisfactory, please consider computers with more advanced spec as the decoding of multiple channels requires good hardware for smooth performance **(\*1)**.

PC Spec <b>(*2)</b>	Minimum Requirements
CPU Processor	Intel Core 2 Quad 2.66 GHz
RAM	4GB <b>(*3)</b>
Network	Ethernet (1000 Base-T recommended)
Operating System	Windows 7 and Windows 8 (All versions) <b>(*4)</b>
Display Resolution	1080p
Browser	Internet Explorer 9.0 or 10.0

**\*1** The quality of video display performance lies not only in the hardware but a few variables. Please refer to Video Display Performance on page 13 for instructions on how to achieve ideal video performance.

**\*2** PC spec requirements are the same for 32-bit and 64-bit systems.

**\*3** Microsoft Windows operating system has limits on memory and address space, regardless of the real or virtual memory available on a particular computer. Please use 64-bit system if your computer has more than 4GB RAM.

**\*4** Please make sure your operating system is fully patched with the latest service packs.



## Video Display Performance

On a **live** or **playback** screen, ENR handles displayed video based on the combination of the following factors, which you should put into consideration when configuring your view layout:

- (1) The number of channels of your current layout
- (2) The format of video stream, e.g. resolution and frame rate.

To balance the loading of the system, ENR will **decode only I frames (\*1)** for live view when CPU usage is critical. The video stream is still recorded at its original frame rate regardless of the display quality.

To acquire good video display quality, however, it is suggested that you try to use the layout containing **just enough** channels, or make use of **Sequence Patrol** function.

### Local Live View / Playback

On **local display**, ENR determines when to enter Decode-I mode according to these key references – (1) your selection of **Layout** and (2) the **Video Resolution**. A layout consisting of more channels and high-resolution streams are considered more CPU consuming, which is more likely to trigger Decode-I mode. Take ENR-1100 for example, by switching the live screen layout from **4x4** style (**16** channels) to **Quad** style (**4** channels), the video quality will appear much smoother.



On a **local live** or **playback** screen, try to meet the conditions below for ideal video display quality(12~30 FPS); otherwise, ENR will decode only I-frames for each channel.

Model	Layout Style	Maximum Video Resolution on Live Screen	Maximum Video Resolution on Playback Screen
<b>ENR-1000</b>	1, 2, 4	<b>1920 x 1080</b>	<b>1920 x 1080</b>
<b>ENR-1100</b>	1, 2, 4, 1+5, 2+4, 1+7, 9		
<b>ENR-1200</b> <b>(*2)</b>	1, 2, 4, 1+5, 2+4, 1+7	<b>1280 x 720 (*3)</b>	<b>1920 x 1080 (*3)</b>
<b>ENR-2000</b> <b>(*2)</b>	1, 2, 4, 1+5, 2+4, 1+7	<b>1280 x 720 (*3)</b>	<b>1920 x 1080 (*3)</b>

**(\*1)** A video sequence is composed of a series of **GOP** (Group of Pictures). Among these pictures, **I-frame** (Intra-coded picture) is a fully specified picture with complete image information, while P-frame and B-frame hold only partial image information.

**(\*2)** ENR-1200 and ENR-2000 will automatically turn all channels into Decode-I Mode when the number of layout channels exceeds **8**.

(\*3) ENR-1200 and ENR-2000 will automatically turn a channel into Decode-I Mode when its video resolution is above **1280 x 720** pixels.

### Remote Live View

Aside from user's behaviors, the hardware specifications of each remote client computer will affect the live display quality. ENR system will observe the outcome of all the variables (such as dynamic CPU loading) to make adaptations.

For live display, you may select a desired display mode to suit your system condition. On **remote live** screen interface, click "**Application**" and select "**Decode I-frame**" or "**Auto Drop Frame**".

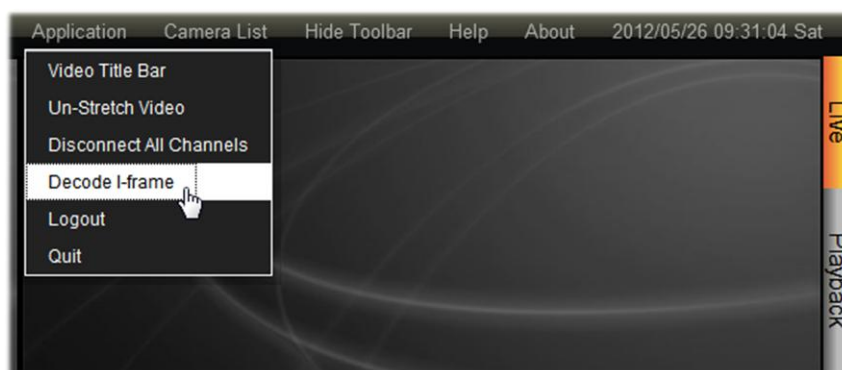

You can adopt **Decode I-frame** mode or **Auto Drop Frame** mode based on your client PC condition:

Condition	Decode I-frame mode	Auto Drop Frame Mode (Default)
<b>Scenario</b>	The client PC is with basic-level hardware	The client PC is with advanced-level hardware or dedicated for displaying ENR Live screen
<b>Purpose</b>	Saving as much CPU usage as possible for other tasks operated on this PC	Displaying as many video frames as possible to achieve smooth video performance
<b>Display Rule</b>	Decodes I frame only	Whenever the CPU loading exceeds <b>80%</b> , random channels will start to decode I frame for about 15 seconds, and then return to original frame rate later. This process will continue until <ul style="list-style-type: none"> <li>●The CPU loading drops under <b>80%</b></li> <li>●User switches to another layout or page</li> </ul>

### Remote Playback

Up to **4**-channel synchronized playback is allowed on a remote client's screen.

## Supported Video Format

As 1080p HDMI monitors have become the most extensive display standard used in various applications, ENR is designed to conform to this standard with its capability of outputting 1080p video stream. Therefore, to conserve as much computing power for ENR unit as possible, only up to two-megapixel H.264 video stream can be displayed on local live screen and local playback screen.

With a client computer, you may still acquire full support for displaying these types of video codec – MPEG4, MJPEG and H.264, and up to ten- megapixel video resolution from web client interface; also, the video stream is recorded at your desired format regardless of the displayed quality.

	Camera Management Export / Recording	Local Live View / Playback	Remote Live View / Playback
Codec	MPEG4 MJPEG H.264 (*1)	H.264 (*2)	MPEG4 MJPEG H.264
Resolution	Up to 3648 x 2736 pixels	Up to 1920 x 1080 pixels (*3)	Up to 3648 x 2736 pixels

\*1 ENR's "Auto Add" function will only add H.264 video streams.

\*2 H.264 is the only displayable codec for local live view and playback. The channels using other codec will appear blank, although the recording is proceeding normally.

\*3 ENR local live and playback can display up to two-megapixel resolution video. The channels using higher resolution video stream will appear blank, though the recording is proceeding normally.

# Get Started

## What's in the Box

This product package includes the following items:



Item	Description
1	ENR Server x 1
2	Printed quick installation guide x 1
3	12V AC power adapter x 1
4	Hard disk screws x 8
5	<p>Adapter converter set x 1</p> <p>This unit contains three types of adapter plugs – UK type, US type and Europe type. These adapter plugs do not change the voltage, but will only change the shape of adapter to fit your electrical outlet.</p> <p>Please detach the plugs, take the plug type you need and connect it to the AC power adapter.</p>
6	USB Mouse x 1

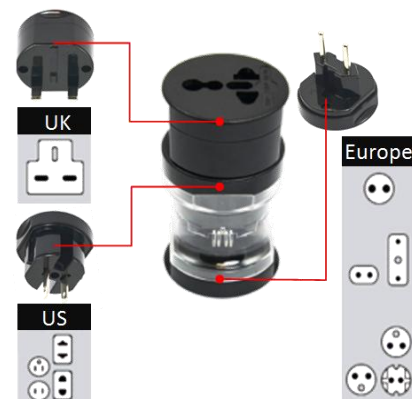

## At A Glance

---

### Front Panel

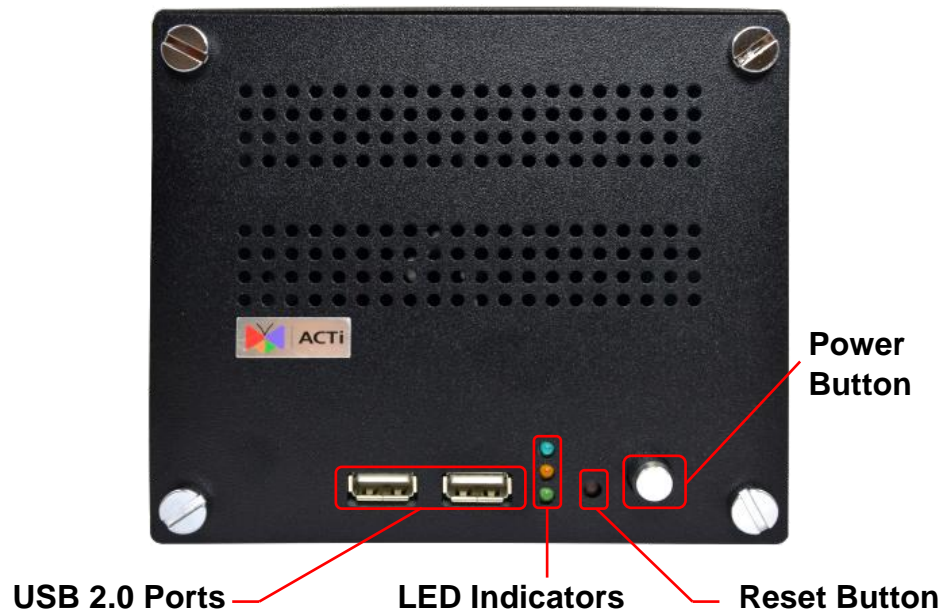

### Rear Panel

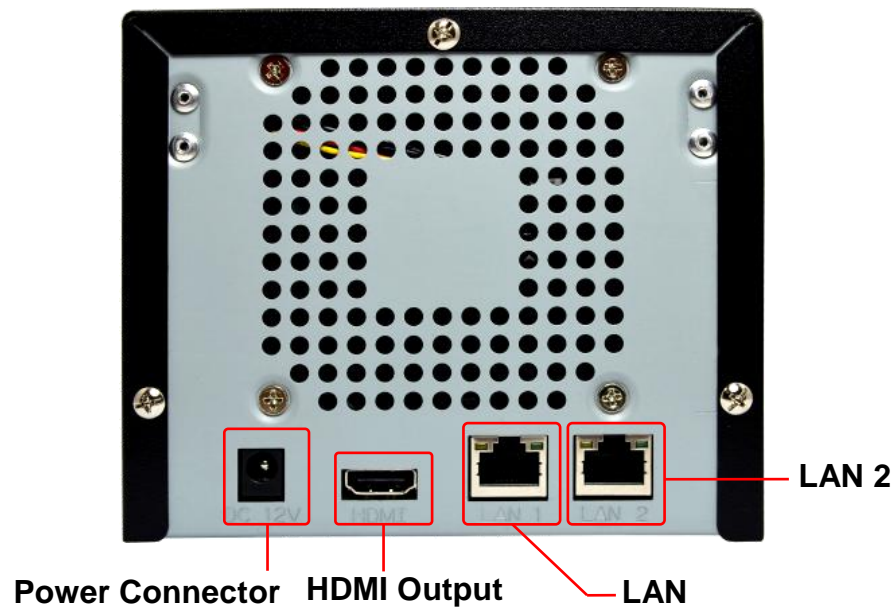

## Power Button & Reset Button

You can turn on / off the unit with **Power Button**.

### Turn on the Unit

Press down the **Power Button** and release, the **Power LED** will light up and turn solid blue.

### Turn off the Unit

As the unit is powered on, the **Power LED** and **System LED** are both lit, and the **Power Button** is in pressed state. To turn ENR off, please do the following:



1. On **Live** screen, click **Setup** → **Power** tab, and click "**Shutdown**".

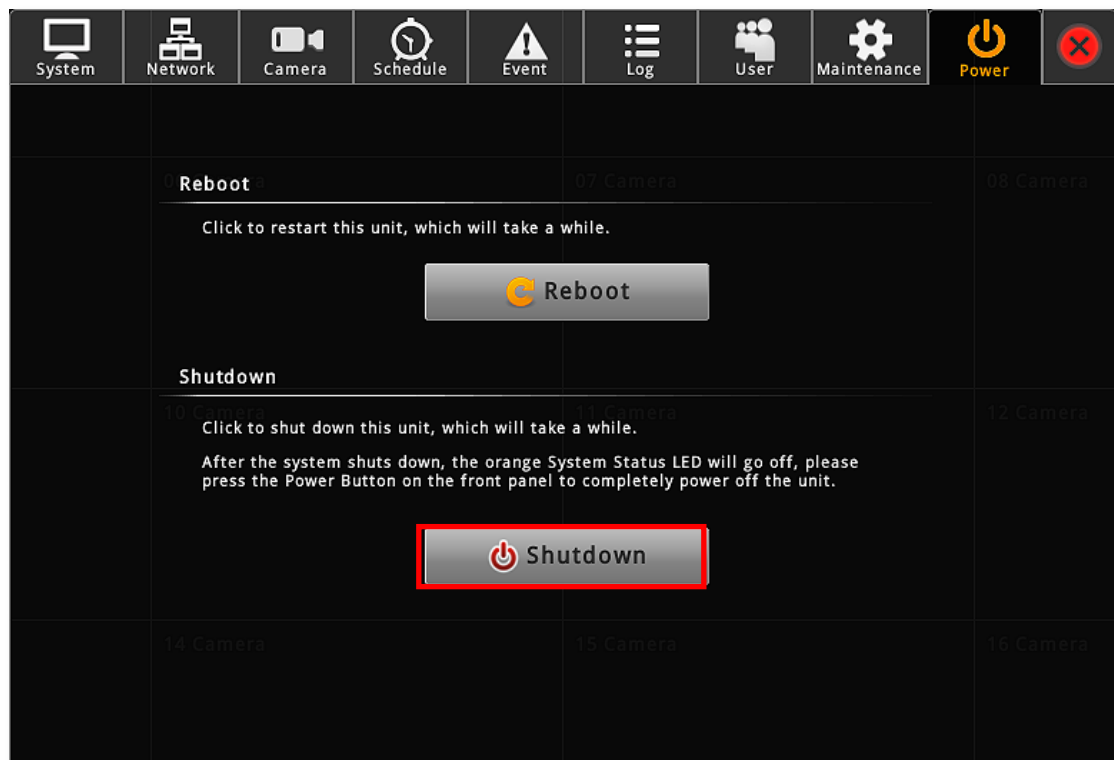

2. The local display screen will turn black, with an information dialogue box showing up. Please observe the **System LED** on front panel, when its orange light is off, you may press the **Power Button** to completely shut down the device.

### Reset to Factory Default

By resetting this device, all your system settings will return to factory default, while the previous recording files are still kept on storage disks. It is strongly recommended that you back up previous settings with **Backup** function before resetting to factory default.

1. To begin, please turn off the unit first.
2. Press down the **Power Button** to boot up the unit, immediately press and hold the **Reset Button** with a pin or clip, the orange **System LED** will light up for about 2~3 seconds, and you may release the **Reset Button** as the light is off, the unit will start the resetting process.



After the unit automatically reboots, the resetting process is done and you may log in.

### LED Indicators

The LED indicators on front panel show the current device status:

Item	Indicator Status	Light Color	Description
<b>Power LED</b>	Solid	Blue	The device power is on.
<b>System Status LED</b>	Lights up for three seconds after <b>Reset Button</b> is pressed	Orange	The system resetting process is initializing.
	Solid		The system service is running.
<b>HDD LED</b>	Flashing	Green	The hard disk is in activity.



# Installation

The installation procedures may vary depending on your site conditions. The procedures provided in this manual are based on an example consisting of (1) local network, (2) an ENR unit, (3) ACTi network cameras, (4) a POE network switch and (5) necessary peripherals.

## Prepare the Devices

Before starting connecting all the devices together, please read the instructions below to make sure your devices are ready for ENR system installation.

### Cameras

ENR is able to automatically add the connected devices and immediately displays their live streams without your further configurations. Please fulfill the conditions below to make sure your devices are ready for ENR **Auto Add** function:

1. For a device whose settings have been changed from factory default, make sure its output stream is **H.264 encoder type**, (If this device outputs multiple streams at the same time such as a **video server** or a camera in **4VGA** or **6VGA** more, ENR will add **All streams** add **Stream 1**; if this device is in dual-streaming mode, ENR will add **Stream 1** only)
2. The device's connection type is **Dynamic mode** (DHCP Client). You can configure the device's connection settings via **Web Configurator**.

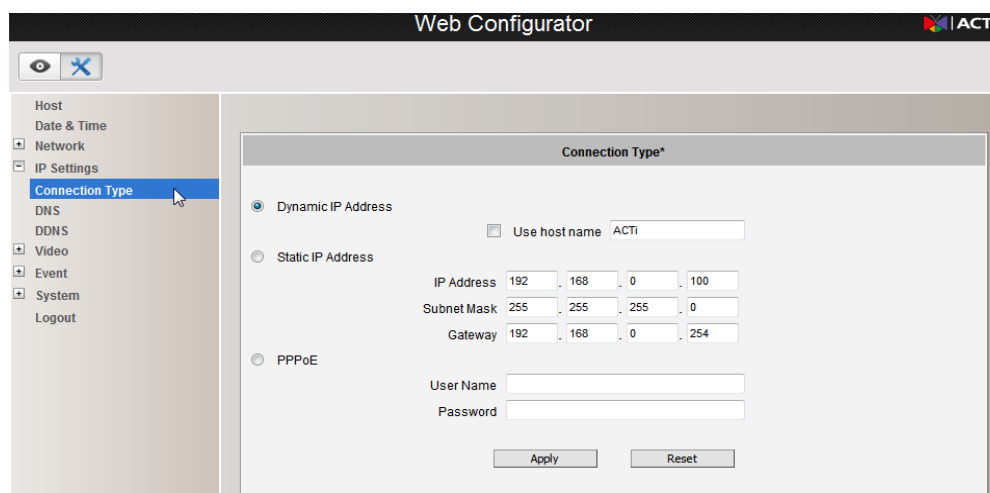

*(ACTi camera web configurator interface)*

If your device is an other brand's product or you would like to add more streams from a device, use **Search Cameras** provided by **Camera Setup Wizard**.



#### Note

Since ENR displays only H.264 stream on local display, any device outputting non-H.264 stream will still be added to ENR system and viewed via the web client interface, while this channel will appear blank on local monitor.

### Monitor

The monitor should supports HDMI port and 1080p full HD resolution display.

### USB Devices

Please use a USB mouse, keyboard or joystick with a cable.

### USB Storage Device

- The USB storage device is required for system backup and system log / snapshot / video export.
- ENR supports all FAT/FAT32/EXT2/EXT3/EXT4/NTFS file systems.

### Hard Disks

For video recordings, you should install **at least ONE** certified 3.5-inch SATA hard disk.

Please always use the hard disks ACTi tested to be compatible with ENR. You may find the certified models with **ACTi Hard Disk Selector** <http://www.acti.com/hddselector>.

## Install the Hard Disks

This system requires at least one hard disk to store video recordings and firmware image when upgrading system. Please follow the instructions below to install your hard disks in correct order to make sure the physical disk locations accord with the **Disk ID** shown in ENR server's **Storage Device List**.

### Step 1 Remove the Case Cover



Remove the four front panel screws, and then remove the three back panel screws.

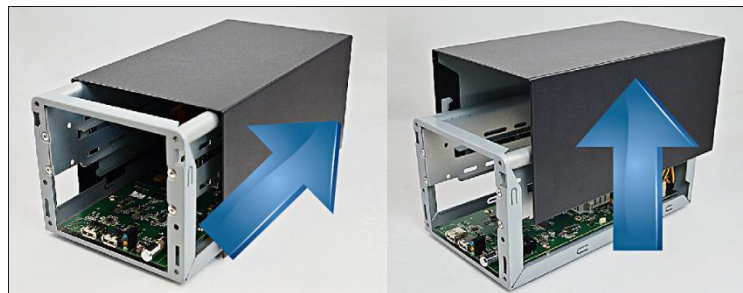

Slide the case backward until it stops, and then lift it up to remove.

### Step 2 Install Disk SATA-2

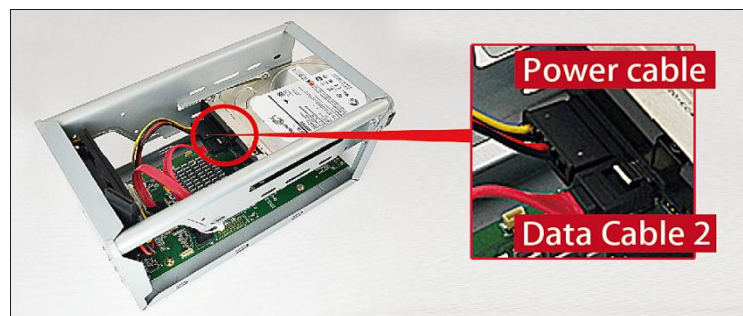

Insert **Disk SATA-2** in the lower bay, connect SATA power cable and SATA data cable 2 to the hard disk.

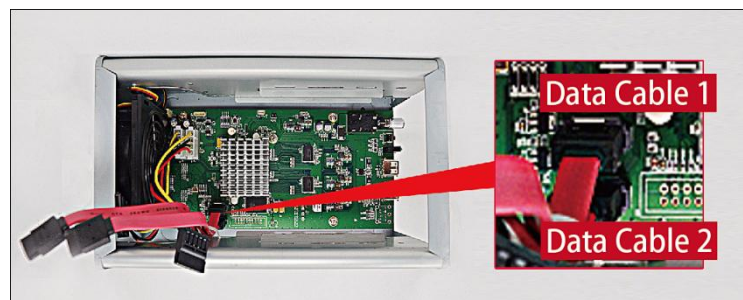

Make sure you connect the correct data cable to the corresponding disk.

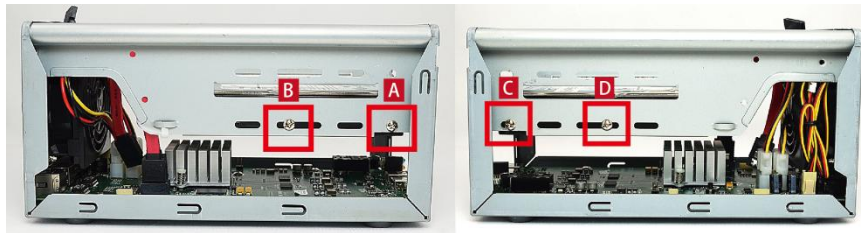

Lock Disk  
**SATA-2** using  
 disk screws in  
 this sequence:  
**A → B → C → D**

### Step 3 Install Disk SATA-1

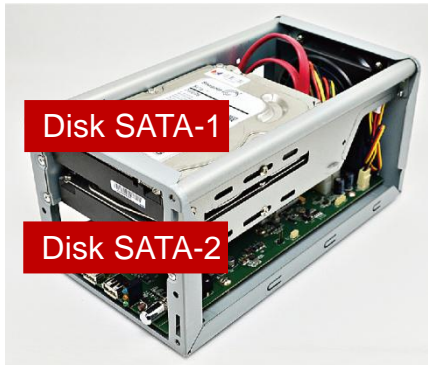

Repeat **Step1~Step3** to install **Disk SATA-1** to the upper bay. Remember to connect **Disk SATA-1** with SATA data cable 1 shown in the illustration in **Step 2**.

### Step 4 Install the Case Cover Back



Install the case in reverse order of removal step (see **Step 2**), slide the case cover back until it clicks. Lock the back panel and then front panel with its screws.

## Network Connection Architecture

When connecting ENR with your network, please make sure you plug the network cable into the right port.



**LAN 1 Port (Camera Port)**

Default: [192.168.0.10](#)



**LAN 2 Port (WAN Port)**

Default: [Dynamic /192.168.1.10](#)

### LAN 1 Port

LAN 1 port is the default camera port for a typical local network. Via this port, the DHCP server built in ENR automatically assigns IP addresses to network cameras once they are connected. With this feature, you do not have to bother arranging the camera IP addresses on your own. By default, this DHCP server is enabled, so please avoid connecting ENR to a network where exists another DHCP server via this port.

### Connection Setting Example 1

The diagram below displays a connection setting example using only **LAN1** to connect networks cameras.

In this setting, ENR altogether with cameras are within the same network segment; in the mean time, there is no need of referencing another DHCP server in this system.

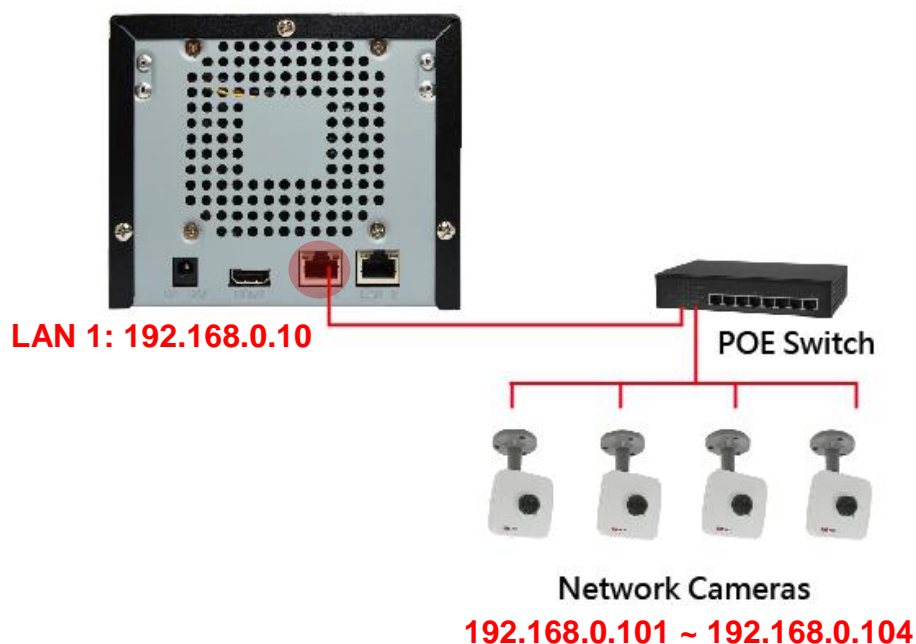

## LAN 2 Port

**LAN2** port is a typical Ethernet port. You will have to use this port to connect with a different network segment when your system requires (1) the connection with a remote PC client or network cameras, (2) the use of event-triggered e-mail service via an external SMTP server (3) the use of date/time synchronization with external NTP server.

By default, once connecting to a network, it will first try to get an IP address assigned by your network router from DHCP server. If your network does not assign IP address automatically, then **LAN2** port will assume IP address **192.168.1.10**.

## Connection Setting Example 2

The diagram below displays a connection setting example using **LAN1** + **LAN2** to connect networks cameras within different network segments.

In this setting, ENR with three cameras are within the same network segment, while there is another camera locating in another network. In addition, this system requires the connection with an external SMTP server and a remote client.

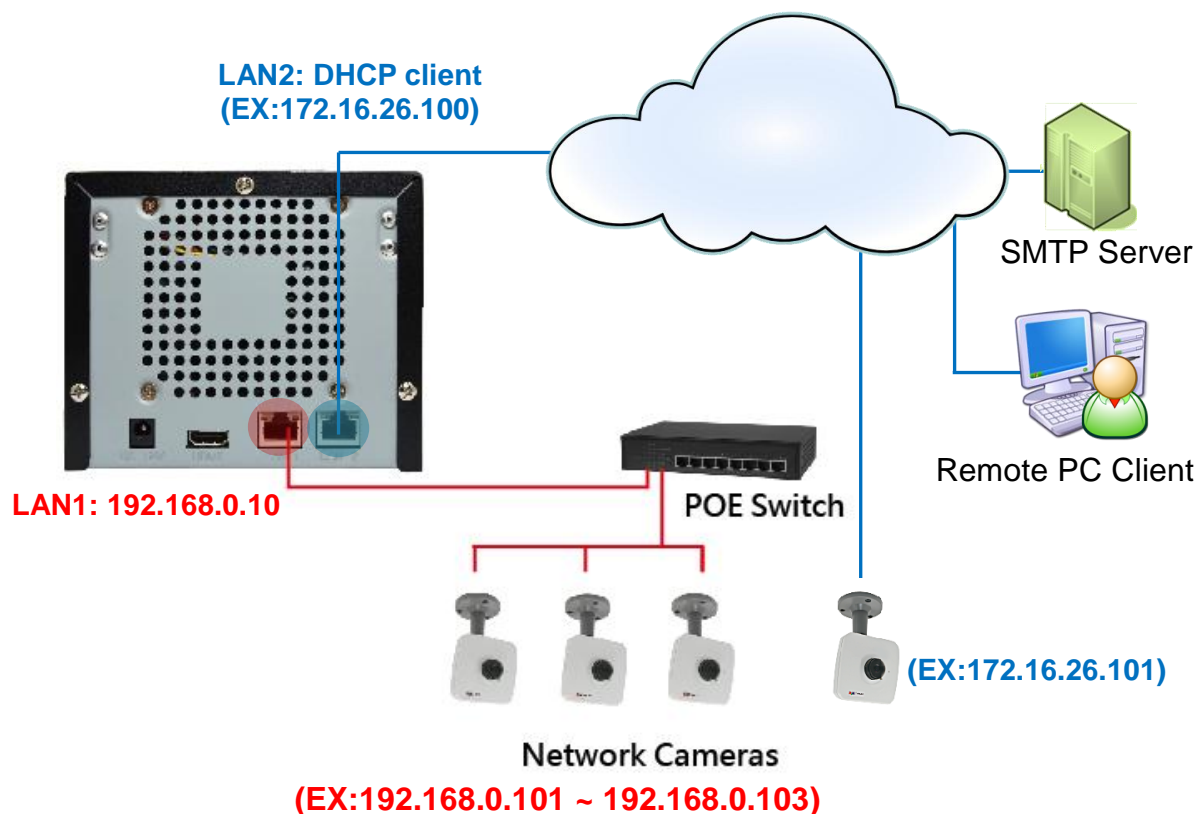

You may check and modify the network configurations by going to **Live** screen → select **“Setup”** → click **Network** tab. (For detailed configuration instructions, please refer to [Network Settings](#) on page 52).

## Connect the Devices

Follow the procedures to connect the devices. These devices are supposed to be connected in the sequence shown below.

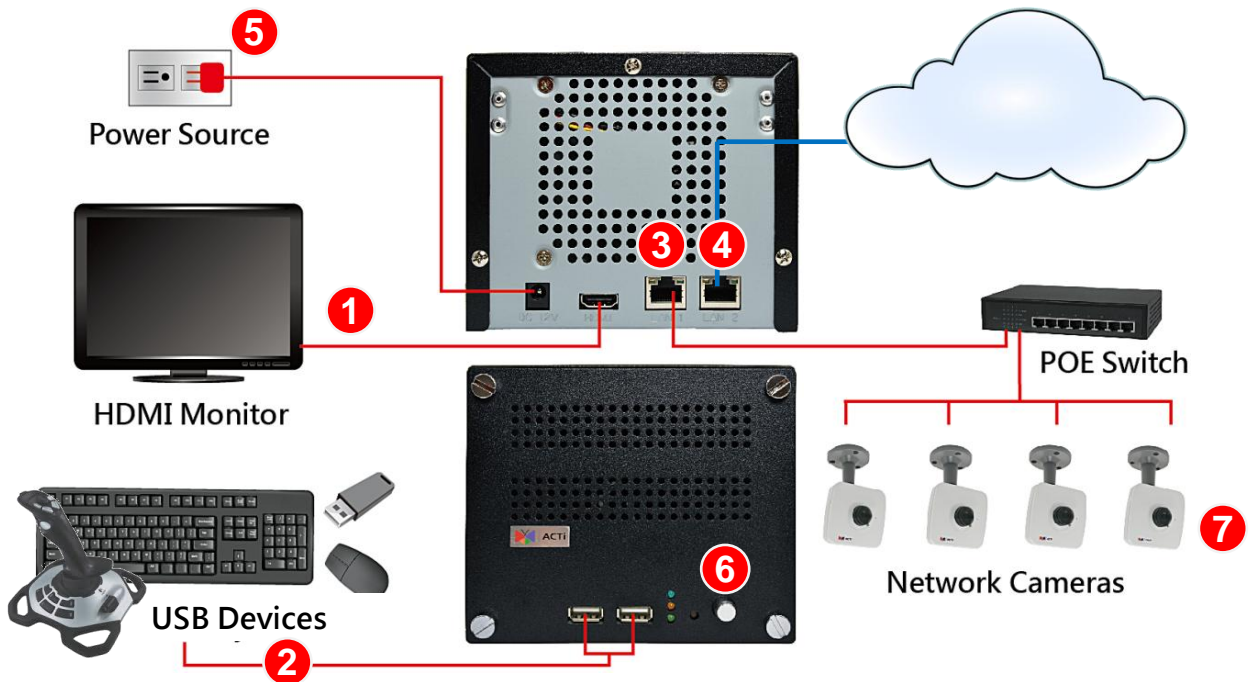

1. Connect the HDMI monitor.
2. Connect the USB devices.
3. Attach the network cable to **LAN1** port.
4. Attach the network cable to **LAN2** port. (Optional, required for remote client connection)
5. Plug the power adapter into ENR and electricity outlet.
6. Press down **Power Button** to start the device, the power status LED will turn solid blue.
7. Connect the network cameras to the switch and power them on.



## Quick Setup

---

By the first time you log in to ENR, the **Setup Wizard** will bring you through the initial setup process. By finishing the quick setup, you will enter live screen immediately.

### Step 1: Log in to ENR

After the device starts, you will first see ACTi splash screen then system interface.



On **Login** window. Click into the **Account** and **Password** fields to enter the default account information - **admin** / **123456**, then click "**Login**".

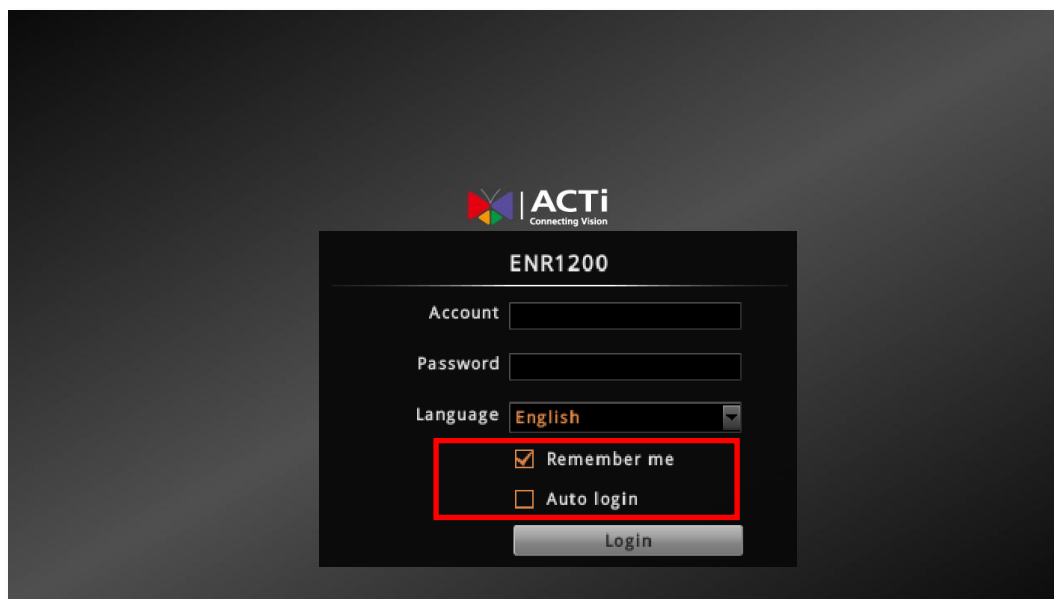

## Step 2: Format the Hard Disks

At present, the hard disks you installed in ENR are not ready for recording, they need formatting before use.

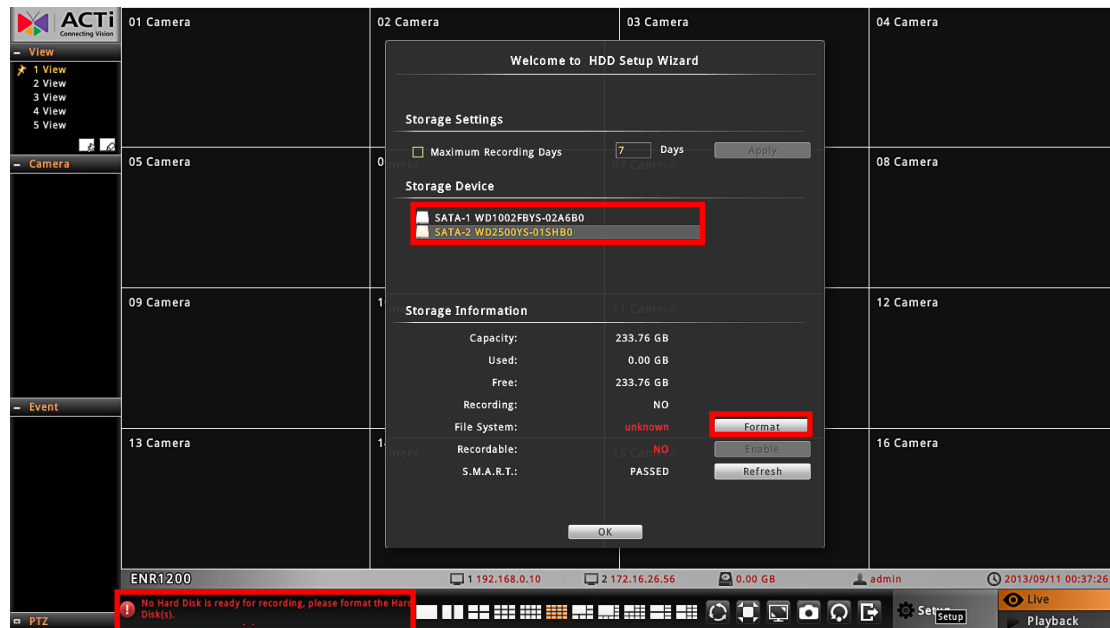

On **HDD Setup Wizard** window, select the unformatted disk and click **Format**. Repeat this step to format the other disk, and then click **OK**. As ENR has successfully formatted a hard disk, a message will pop out to notify you. After a successful formatting, the file system of the disk will show **ENR-FS**, and this disk will immediately become ready for recording,

<i>(Not Formatted)</i>		<i>(Formatted)</i>	
File System:	unknown	File System:	ENR-FS
Recordable:	NO	Recordable:	YES

## Step 3: Add Cameras

Please select **Auto Add** to automatically add cameras or **Search Cameras** to select cameras by yourself.



This will add detected H.264 video streams and display all video streams on **Live** screen right away

Search all the cameras including supported other brand cameras and ONVIF compliant cameras within your current network segment.



## Auto Add

By using **Auto Add** function, ENR will add the first detected H.264 streams. Please input the **Account** and **Password** (this user account must be the camera's root account) to access the cameras.

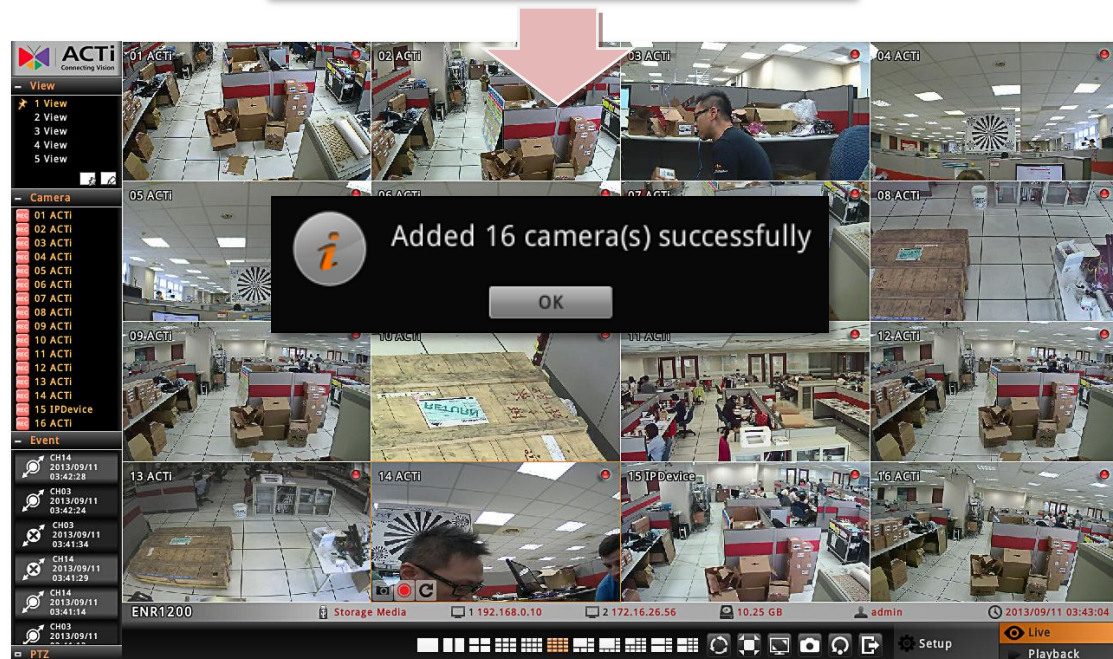
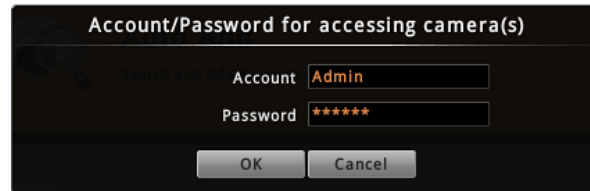

## Search Cameras

**Search Cameras** allows you to select desired cameras, including other brand cameras. By default, ENR will perform an instant search for ACTi cameras using **admin/123456** as account and password to access all cameras. To search for other brand cameras or use other account/ password:

1. Select the camera manufacturer.
2. Input the **Account** and **Password** to access the cameras (this user account must be the camera's root account).
3. Click "**Refresh**".
4. Select your desired cameras and click "**Add**". Please note that your clicking order will affect **Live View** channels arrangement. For example, you select cameras on the search list in this order: TCM-4511 → TCM-5111 → D11 → E52, which will exactly become the channel order: **01 Camera** → **02 Camera** → **03 Camera** → **04 Camera**

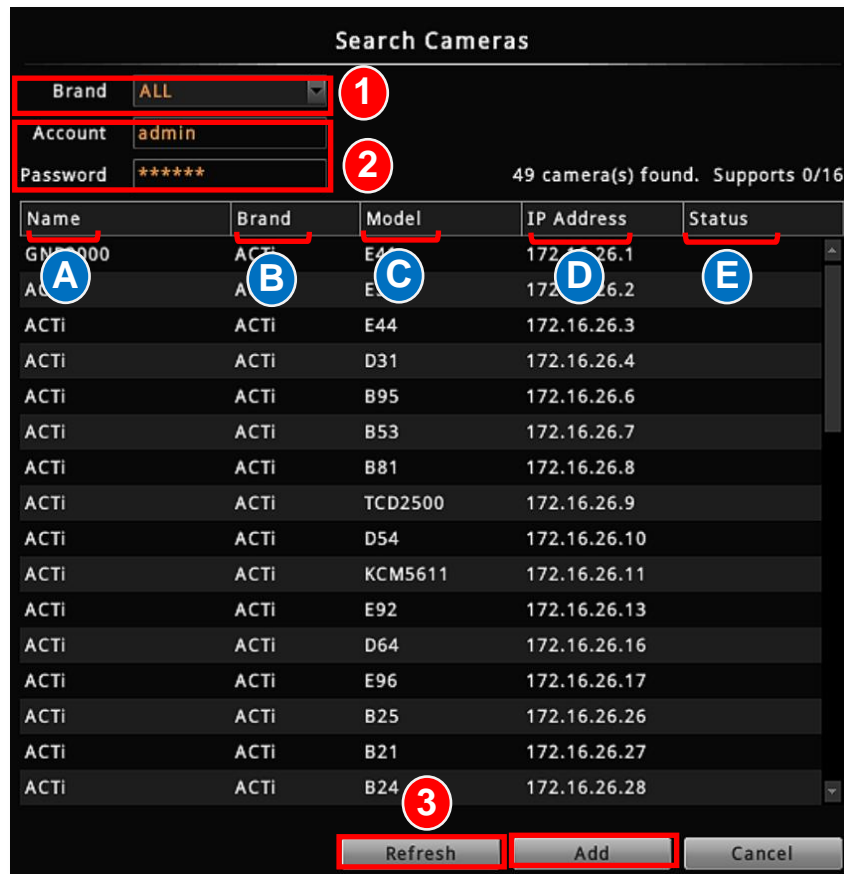

No	Column	Description
A	Name	The camera's name, which you can change on <b>Camera</b> tab later.
B	Brand	Camera manufacturer
C	Model	Camera model name
D	IP Address	Camera IP Address
E	Status	<u>Blank</u> : this camera is accessible and not added yet. <u>In Use</u> : this camera/stream has been added to the system.

### Note

By means of **Auto-add** or **Search Cameras**, ENR will add one H.264 stream from each device. To add other video streams from the same device (e.g. multiple streams from a video server or six VGA streams from a hemispheric camera) please go to **Camera** tab and add them manually.

# Local Client Operation

## Log in to / out of ENR

---

By default, an administrator account has already been existing in your system. To log in to ENR for the first time, you will have to key in the password in **Login** window.

### Log In

If you are not logged in yet, click on screen to bring up the **Login** window.

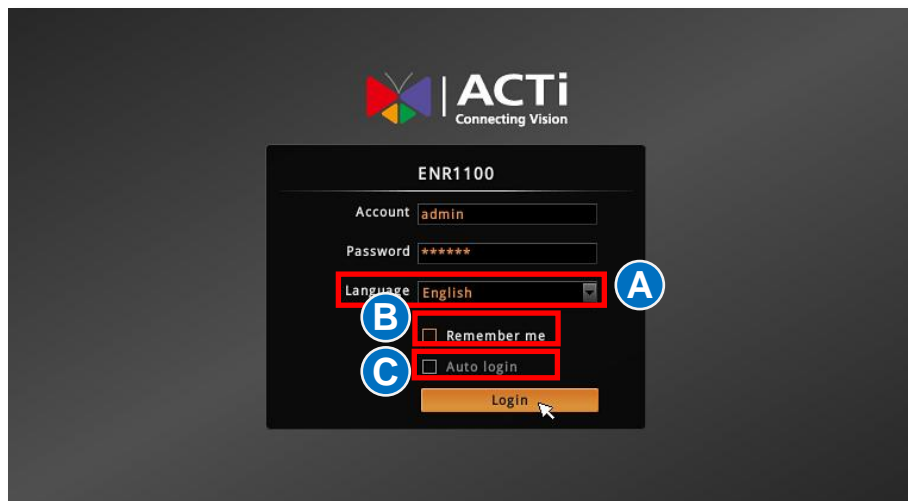

### Change UI language **A**

To change UI language, select the desired language from “**Language**” dropdown list.

### Remember Login Information **B**

To have the server remember your **Account**, **Password** and language setting for future, check “**Remember me**”.

### Set Auto Login **C**

Check “**Remember me**” then “**Auto Login**”, you will skip the **Login** page and directly enter **Live** screen when accessing ENR in the future. This feature makes using ENR more convenient, however it may pose a security risk because any other user can enter ENR using the account you established. The **Remember me** and **Auto-login** function will be cancelled when you logout from ENR.

### Log Out

On **Live** screen, click “**Logout NVR**”  .

## Live Page UI Overview

After logging in, you will enter **Live** screen. **Live** screen is the interface where you see the live views from your cameras. It is where most of the security professionals access the surveillance system

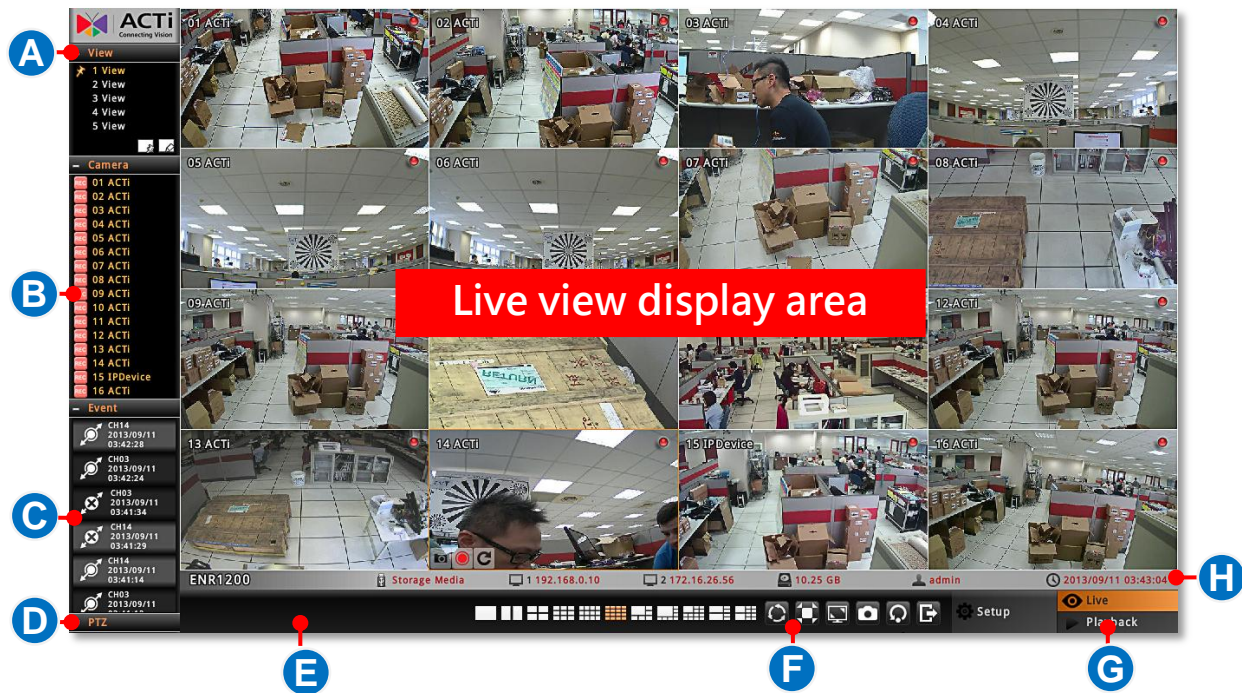

No	Description
<b>A</b>	<b>View List:</b> Lists <b>five</b> views available for customization.
<b>B</b>	<b>Camera List:</b> Lists all the connected cameras and their recording status.
<b>C</b>	<b>Event List:</b> Displays alerts of detected motion, recording and connection status.
<b>D</b>	<b>PTZ Control Panel</b> Provides live onscreen PTZ controls. <u>This panel is only enabled when a PTZ camera channel is selected on live view display area.</u>
<b>E</b>	<b>System Message</b> Displays import messages to inform you of certain system conditions that require your prompt action.
<b>F</b>	<b>Live Menu</b> Lists available layout selection and live view operation controls
<b>G</b>	<b>Page Switch</b> You may switch to the <b>Setup</b> or <b>Playback</b> page by clicking the tags. The <b>Setup</b> page is only accessible from <b>Live</b> page.
<b>H</b>	<b>System Status:</b> Displays the following system status from left to right – (1) connected USB storage device, (2) <b>LAN1</b> IP address, (3) <b>LAN2</b> IP address, (4) total free disk space, (5) your user account and (6) current system time.



## Input Devices

The physical input devices (e.g. USB mouse and USB keyboard) are ready to use when you connect them to ENR via USB ports.

### Onscreen Keyboard

The onscreen keyboards allow you to input characters without using a physical one. By clicking in a character field (e.g. **Account** or **Server** name) or number field (e.g. **IP address** or **Port**), the specific onscreen keyboard will be brought up.

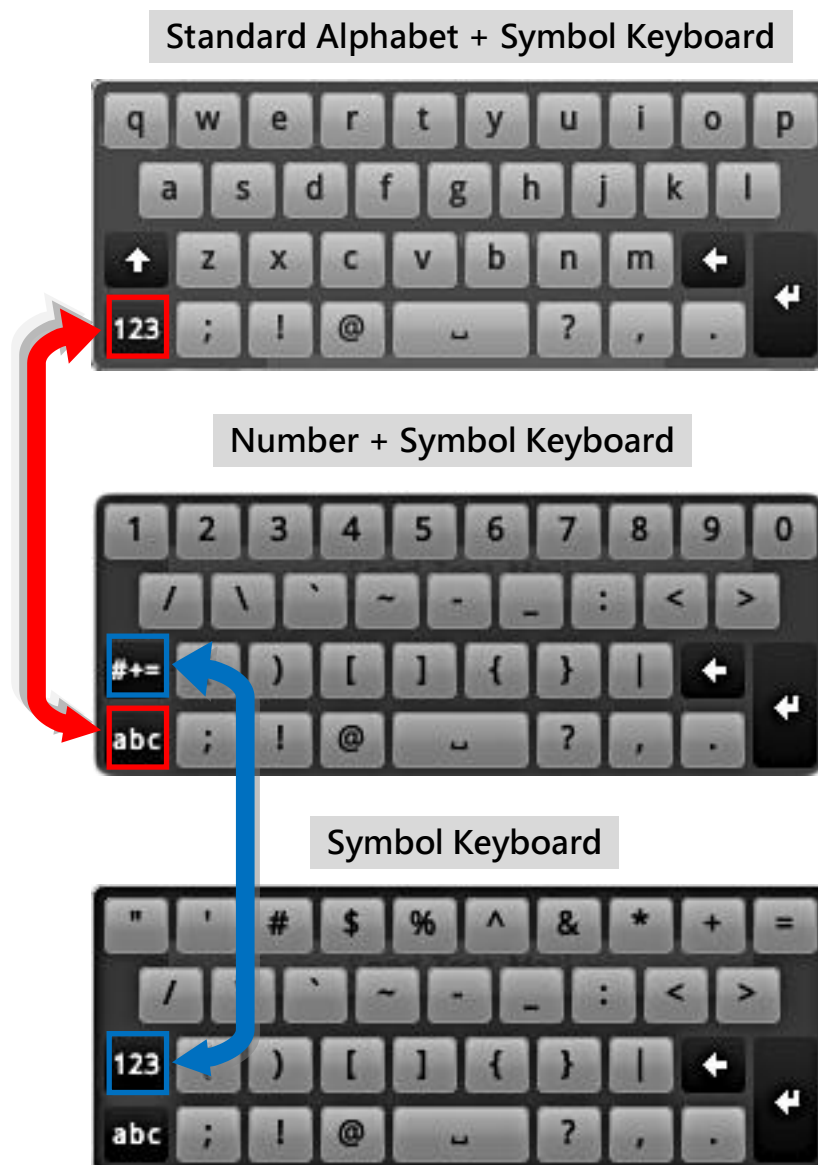

## Mouse Settings

You may adjust the mouse's cursor speed via the path below:

On **Live** screen, click **Setup** → select **System** tab → click "**Mouse**".



## Onscreen Keyboard Settings

To disable the virtual keyboard if a physical one is already in use, on **Live** screen, click **Setup** → **System** tab → click "**Keyboard**". Uncheck the box "**Always shows software keyboard**".







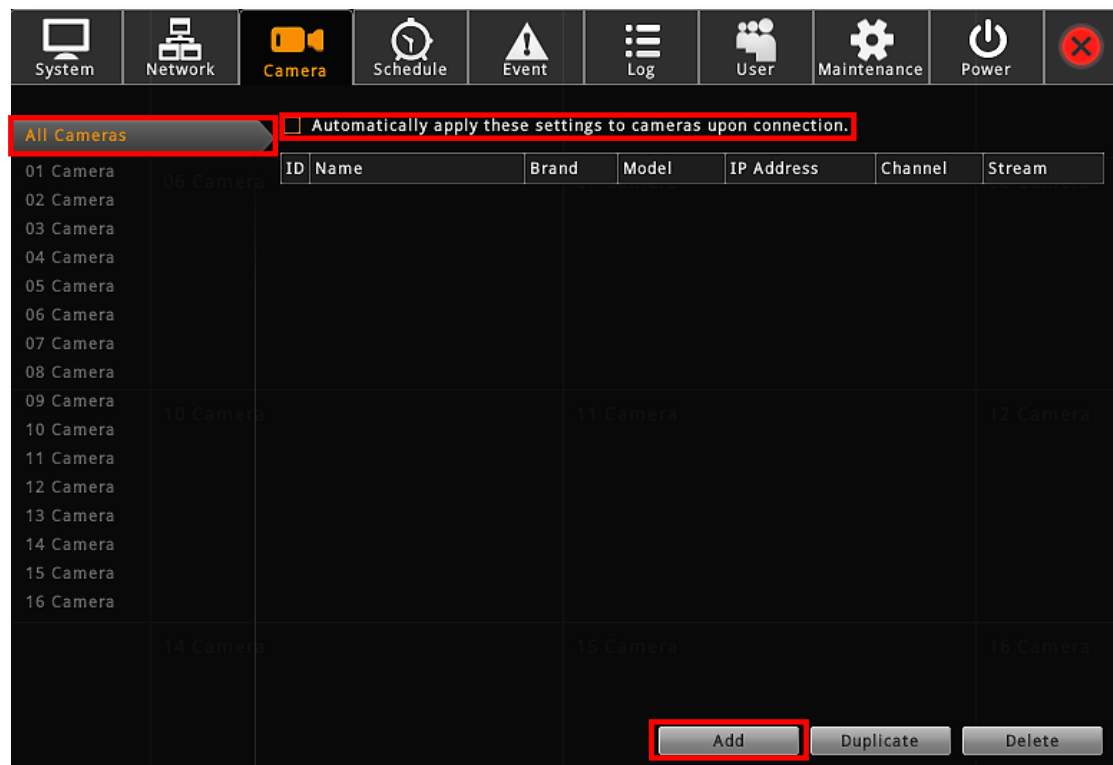

## Set Cameras

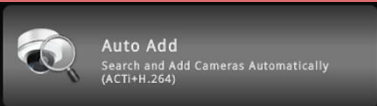
ENR user interface also allows you to easily configure, add or delete cameras without the use of another web browser. On **Live** page, click **Setup** → **Camera** tab. “**All Cameras**” display all the added cameras, click “**Add**” to start adding cameras.

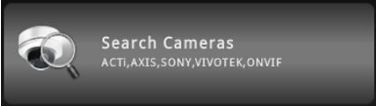
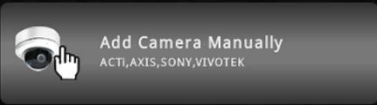

ENR is capable of supporting a wide range of devices besides an ACTi products; the table below provides the recommend methods to use when adding your devices in order to achieve the utmost out of the products. Please note that the “**Auto Add**” function is only provided on **Setup Wizard** interface during the initial system setup.

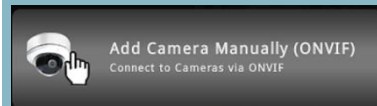
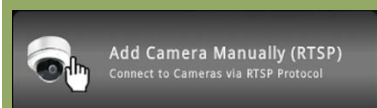
	In ENR's network segment	In another network segment
<b>ACTi cameras</b>	 <p>This method is available as long as no device has been added to the system and on Setup Wizard window. It will add all H.264 video streams from ACTi devices.</p>  	
<b>ENR supported other brand cameras</b>	 	
<b>ONVIF compliant cameras (not yet supported by ENR)</b>		ENR supports video, audio and basic camera configurations to ONVIF compliant devices.
<b>Other cameras</b>		For other brand camera that is neither ONVIF compliant nor supported by ENR, you can add its video stream via RTSP protocol.

### Note

ENR will synchronize with devices upon connecting to them. To make sure the settings on ENR side are prior to those on camera sides, please check “**Auto save ENR settings into device upon connection**”. When this function is enabled, every modification you make via camera web configurator will be overwritten by ENR.



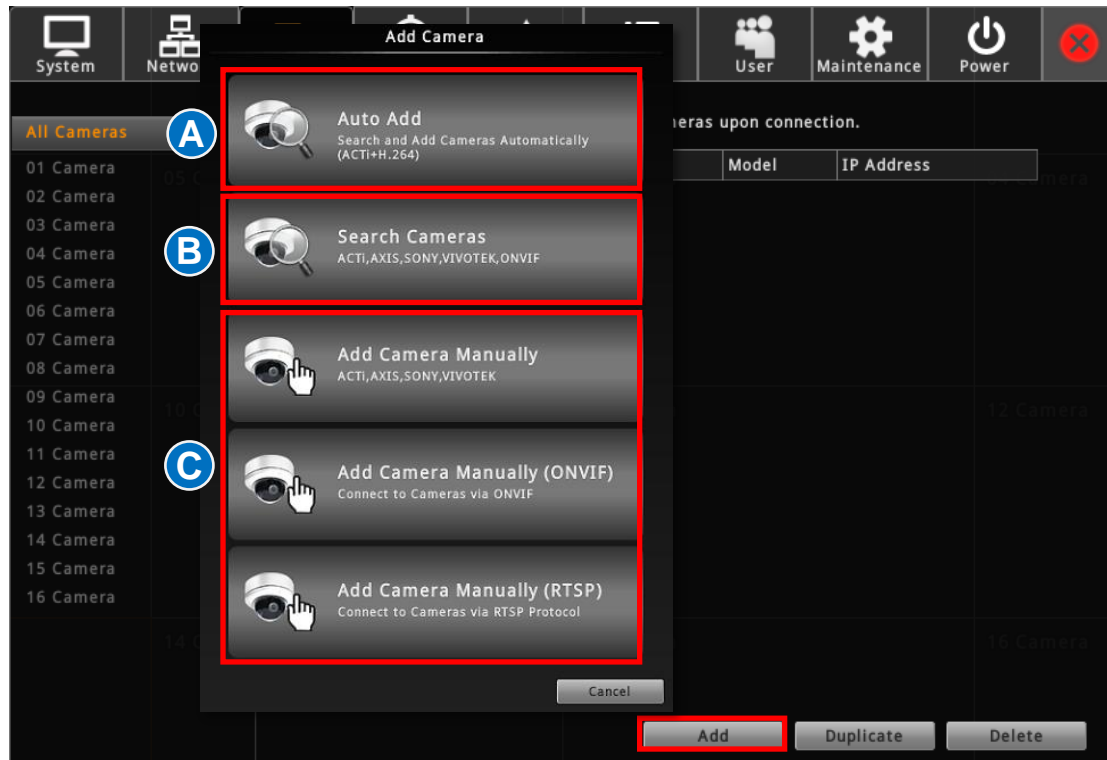

## Add Cameras

Click **“Add”**. There are five methods you can use to add cameras:

**(A)** Click **Auto Add** to have ENR automatically add all

H.264 video streams from ACTi cameras. This is the same quick method provided by **Camera Setup Wizard**, please refer to Auto Add on page 29 for

instructions. It is the recommended method for instantly adding multiple streams from the

same device (e.g. 16 channel video server).

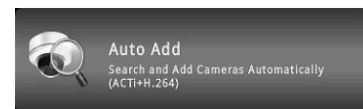

**(B)** Click **Search Cameras** to scan through the available

video sources in your network including other brand

and all ONVIF compliant devices, and select desired

cameras to add by yourself. This is the same quick method provided by **Camera Setup**

**Wizard**, please refer to Search Cameras on page 29 for instructions.



**(C)** You can add a device by filling its connections properties.

Use this method when:

- this device is not located in the same network segment with ENR server.
- you want to add a specific **ONVIF** compliant device.
- you want to add a stream via **RTSP** protocol.



## Add Cameras Manually

1. Fill in the connection properties such as properties **IP Address**, **Port**, **Username** and **Password**, and click **“Get Camera Settings”**.

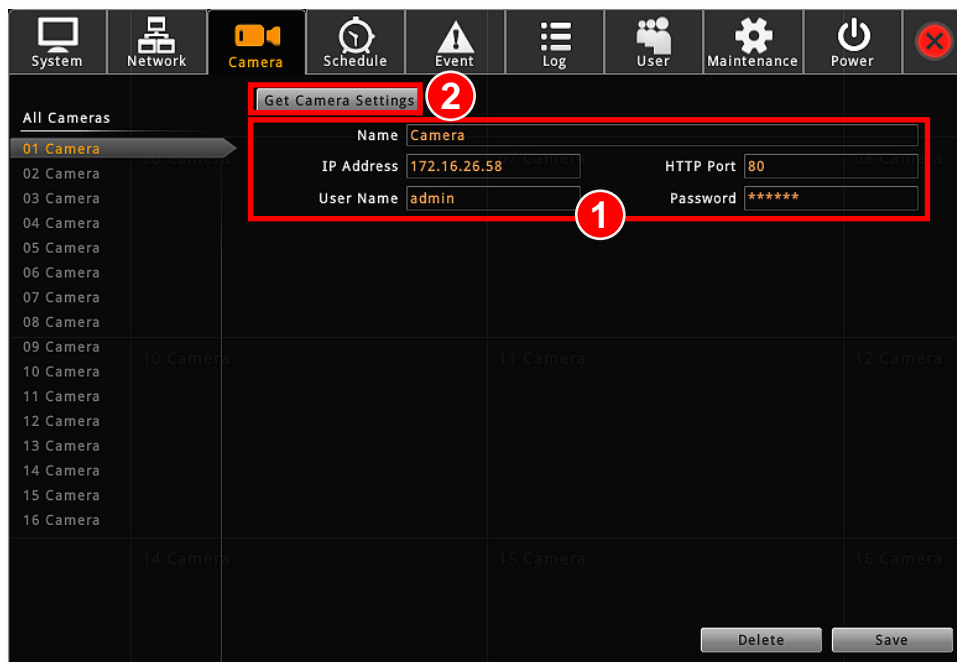

2. The camera settings will appear. Click **“Save”** to save it to this camera channel.



## Add Cameras Manually (ONVIF)

You can manually add a camera through RTSP protocol without to the camera brand.

1. Fill in the properties, and then click “**Get Camera Settings**”.

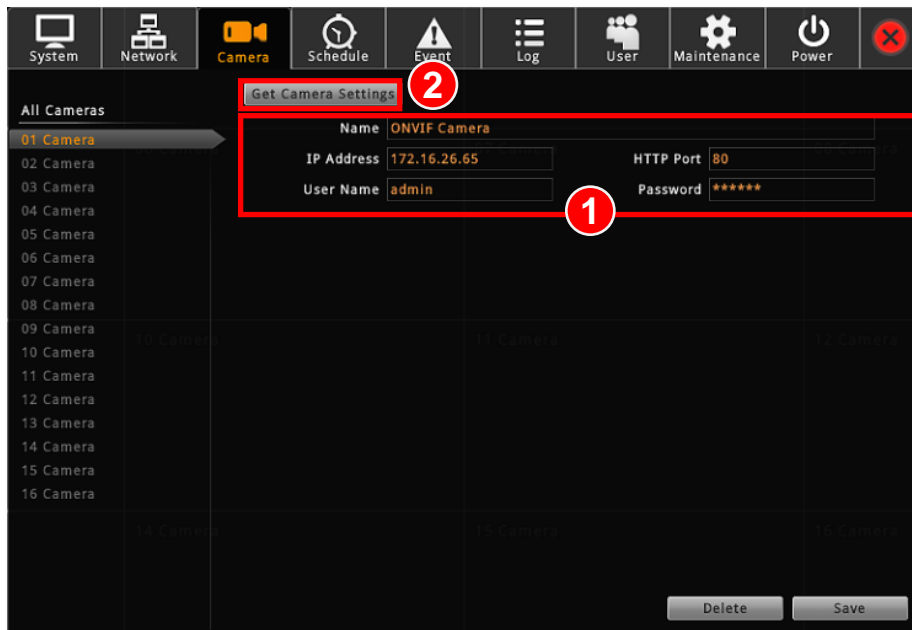

2. The camera settings will appear. Click “**Save**” to save it to this camera channel.

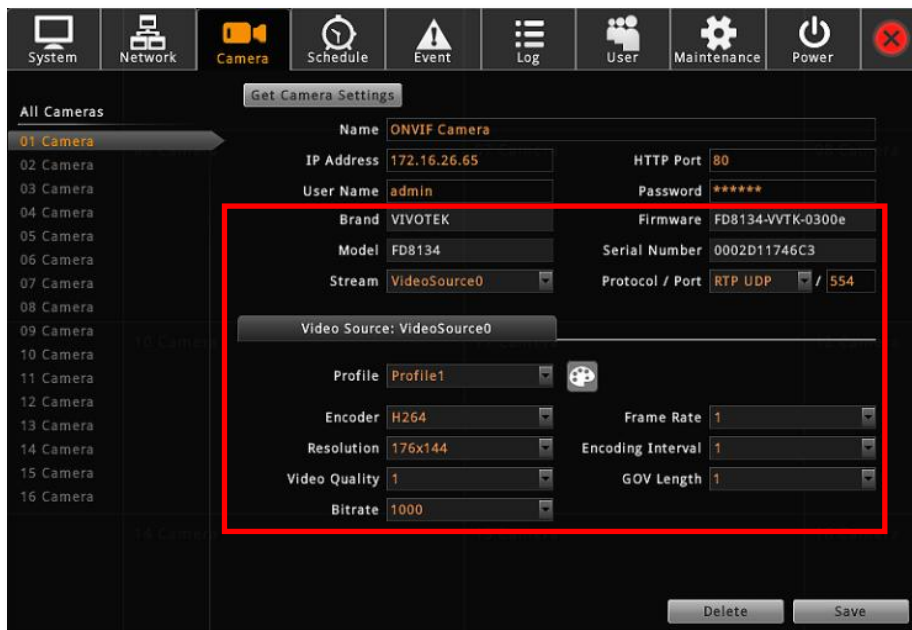

3. You may configure advanced camera setting by clicking on .

## Add Cameras Manually (RTSP)

Fill in the properties, make sure you select the correct **URI** type and **Protocol** type, and then click **“Save”**. This stream will immediately be added to the system and displayed on live screen.

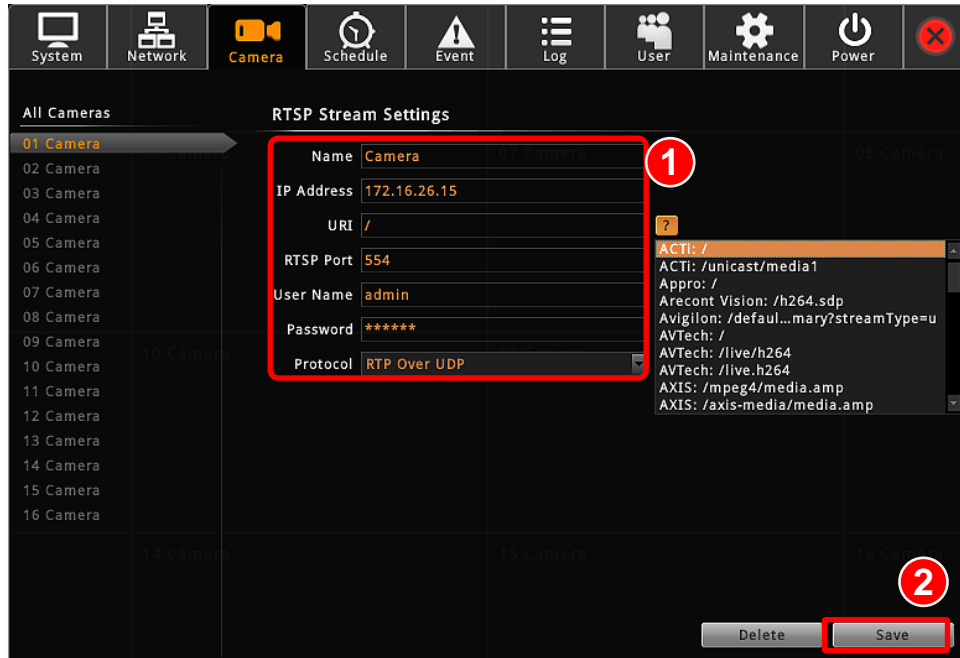

## Copy Camera Settings

You may copy an added camera's settings to another **empty** channel. In this way, it is easier to manually add more than one camera of the same models.

On **Camera** tab, enter **All Camera** list, select the cameras you want to duplicate, and click **"Duplicate"** The new cameras will be added to the list.

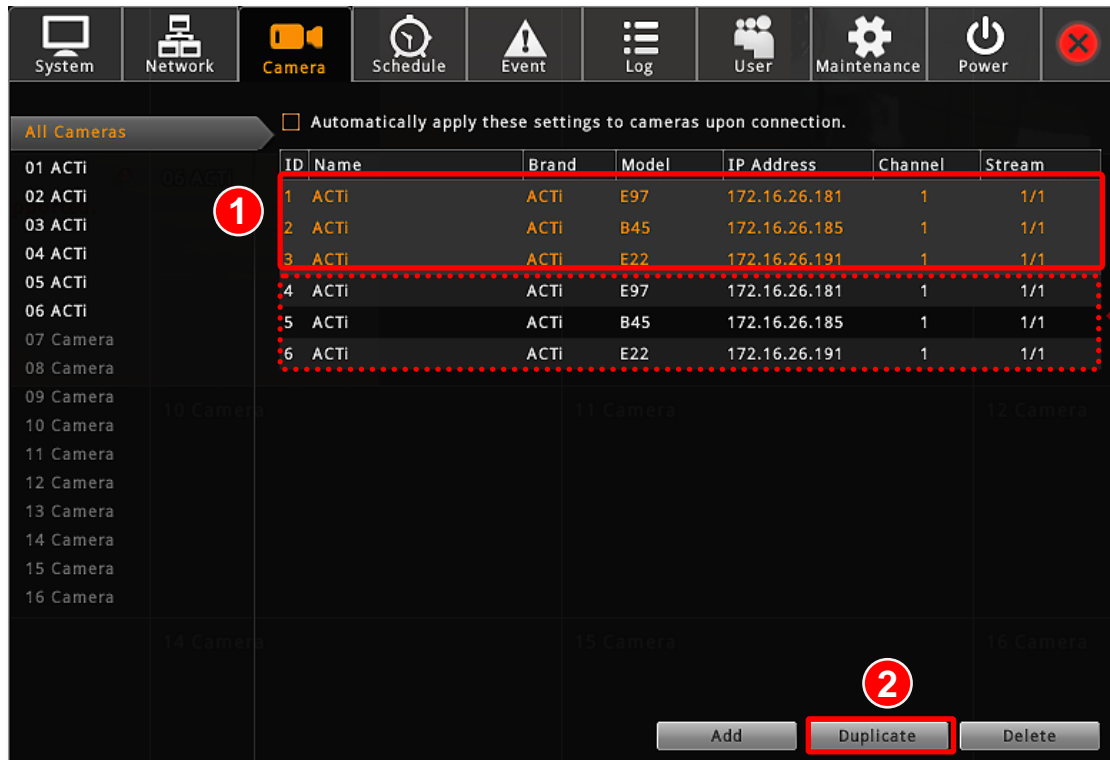

System Network **Camera** Schedule Event Log User Maintenance Power

Automatically apply these settings to cameras upon connection.

ID	Name	Brand	Model	IP Address	Channel	Stream
1	ACTI	ACTI	E97	172.16.26.181	1	1/1
2	ACTI	ACTI	B45	172.16.26.185	1	1/1
3	ACTI	ACTI	E22	172.16.26.191	1	1/1
4	ACTI	ACTI	E97	172.16.26.181	1	1/1
5	ACTI	ACTI	B45	172.16.26.185	1	1/1
6	ACTI	ACTI	E22	172.16.26.191	1	1/1

01 ACTI  
02 ACTI  
03 ACTI  
04 ACTI  
05 ACTI  
06 ACTI  
07 Camera  
08 Camera  
09 Camera  
10 Camera  
11 Camera  
12 Camera  
13 Camera  
14 Camera  
15 Camera  
16 Camera

14 Camera 15 Camera 16 Camera

1 2

Add Duplicate Delete

## Delete Cameras

You may delete one channel at a time or delete more all at once.

On **Camera** tab, enter **All Camera** list, select the cameras you want to delete, and click **Delete**. To delete multiple cameras at once, you can use the mouse to drag out a selection range and then select **Delete**.

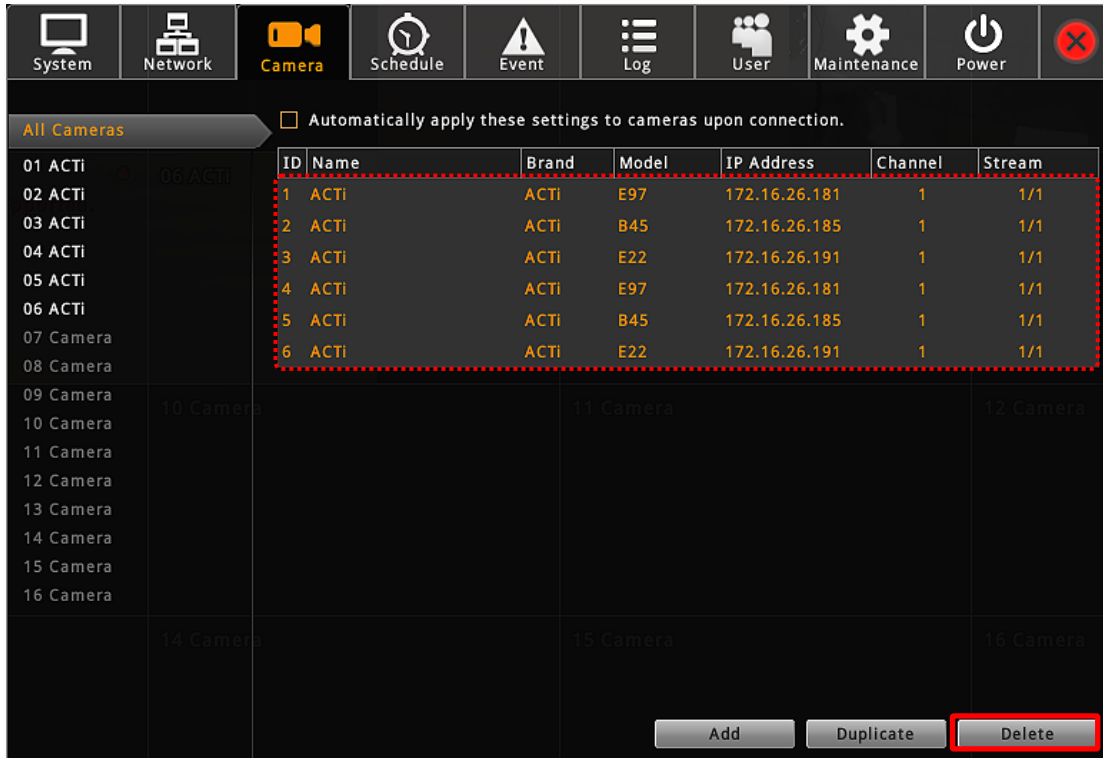

The screenshot shows the 'Camera' tab in the system administrator interface. At the top, there is a navigation bar with icons for System, Network, Camera (selected), Schedule, Event, Log, User, Maintenance, Power, and a close button. Below the navigation bar, there is a section for 'All Cameras' with a checkbox for 'Automatically apply these settings to cameras upon connection.' A table lists camera configurations with columns for ID, Name, Brand, Model, IP Address, Channel, and Stream. The first six rows of the table are highlighted with a red dashed border. At the bottom right, there are three buttons: 'Add', 'Duplicate', and 'Delete' (highlighted with a red border).

ID	Name	Brand	Model	IP Address	Channel	Stream
1	ACTi	ACTi	E97	172.16.26.181	1	1/1
2	ACTi	ACTi	B45	172.16.26.185	1	1/1
3	ACTi	ACTi	E22	172.16.26.191	1	1/1
4	ACTi	ACTi	E97	172.16.26.181	1	1/1
5	ACTi	ACTi	B45	172.16.26.185	1	1/1
6	ACTi	ACTi	E22	172.16.26.191	1	1/1

## Change Camera Settings

After the cameras are added, you may change their properties on **Camera** tab.

- (A) Video format and transmission properties
- (B) Video adjustment
- (C) Motion Detection settings
- (D) PTZ settings

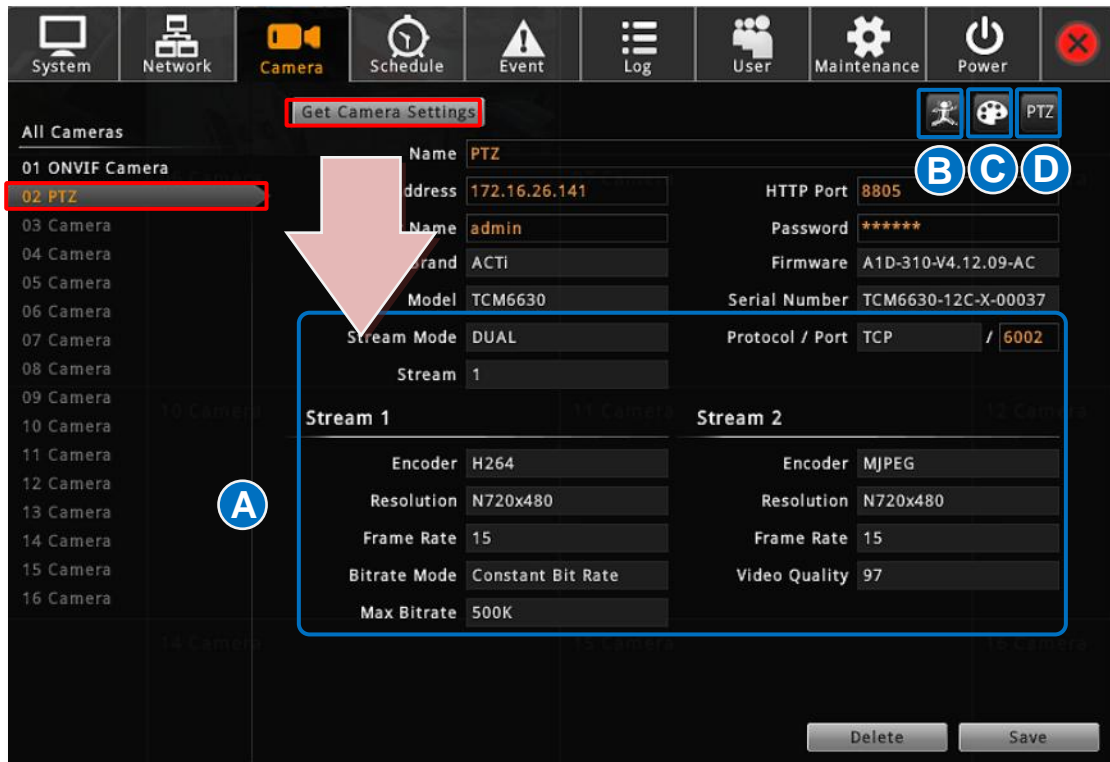

### (A) Video Format and Transmission Properties

To modify the video format and transmission properties including **Channel ID**, **Resolution**, **Frame Rate**, **Protocol**, and **Bitrate**, you will have to click **Get Camera Settings** first to sync with the camera first. After configuration, click **Save** to save this setting to camera

#### Note

1. Changing the video resolution will reset your current motion region settings. Please re-configure the settings later.
2. For local display viewing, please DO NOT (1) change the video resolution to higher than 2M pixels or (2) change the video codec to MJPEG or MPEG4, for these types of video streams are only displayable through ENR web interface.

## (B) Motion Settings

After selecting the camera, click “**Motion Detection Settings**”. If this camera is in dual stream mode, only **Channel ID 1** (Stream 1) supports motion detection feature. On **Motion Detection Settings** window, check “**Enable**” then click “**Motion Setup**”. To enable one motion region, check it, a color frame will appear in the view. You may start setting the detection area by adjusting this yellow frame on the view. Simply use your mouse to move and resize the frame. Click “**Apply**” to save the settings.

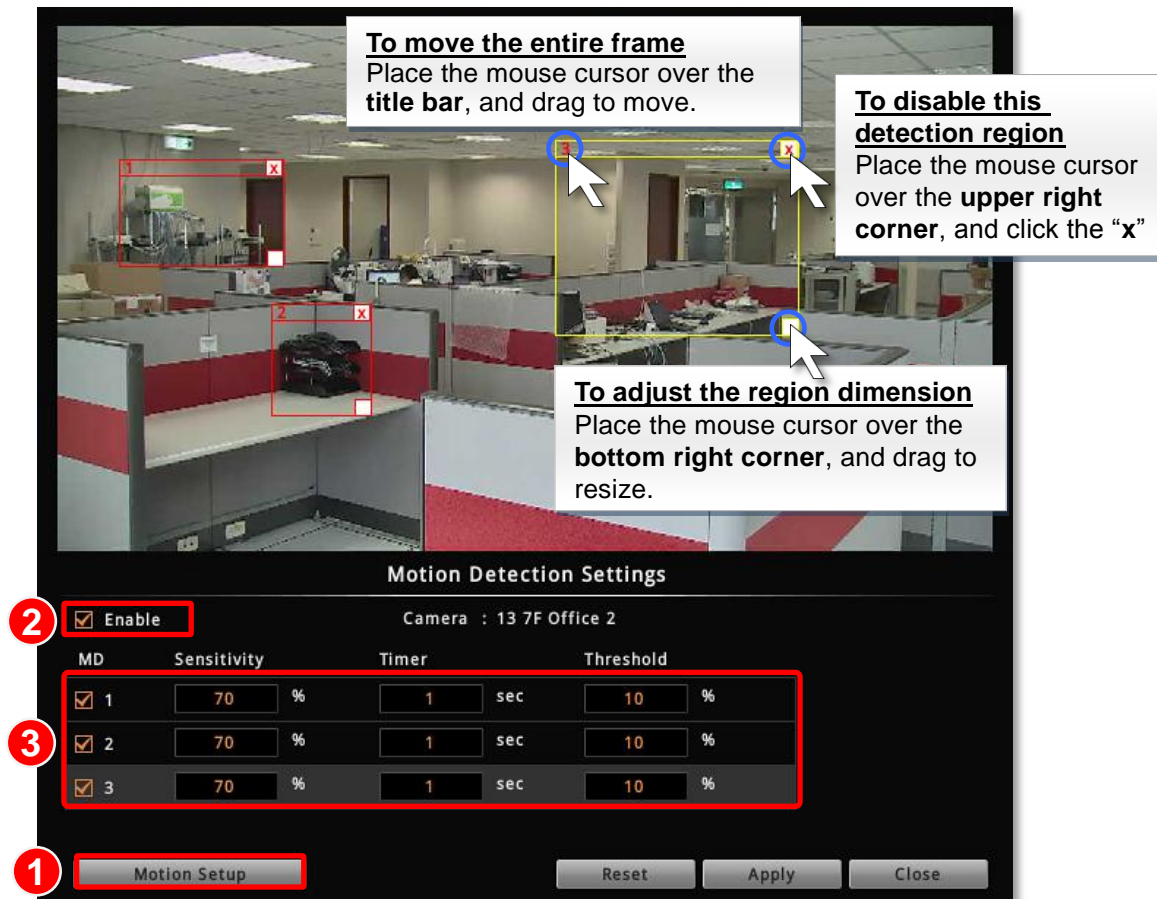

**To move the entire frame**  
Place the mouse cursor over the **title bar**, and drag to move.

**To disable this detection region**  
Place the mouse cursor over the **upper right corner**, and click the “x”

**To adjust the region dimension**  
Place the mouse cursor over the **bottom right corner**, and drag to resize.

**Motion Detection Settings**  
Camera : 13 7F Office 2

**2**  Enable

MD	Sensitivity	Timer	Threshold
<input checked="" type="checkbox"/> 1	70 %	1 sec	10 %
<input checked="" type="checkbox"/> 2	70 %	1 sec	10 %
<input checked="" type="checkbox"/> 3	70 %	1 sec	10 %

**1**

Field Name	Description
<b>Sensitivity</b> (0-100%)	Determines how sensitive the camera reacts to the movement. The higher the sensitivity level is, the smaller motion will trigger the alarm, but may give false alarms. Default is 70%.
<b>Timer</b> (0-300 secs)	The interval before the next motion detection can be triggered again. Default is 1 second.
<b>Threshold</b> (0-100%)	The threshold level of this motion detection region. The lower threshold level is, smaller portion of the region would be considered as motions, which is more easily to be triggered, but may give more false alarms. Default is 10%.



## (C) Fine-tune the Image: Brightness/Contrast/Saturation/Hue

Not only clarity but also brightness, contrast, saturation and hue are essential factors to make images closer to real scene. For cameras that support these configurations, you may directly modify them and save via ENR interface.

After selecting a camera, click “**Video Adjustment**” window, the fields available for modification (depends on models) will be enabled. Select the desired value for the field, and click “**Apply**”.



Field Name	Description
<b>Brightness</b> (1-100)	Defines how much portion of light and of dark appear in the image. As the value increases, the image appears brighter, and vice versa.
<b>Contrast</b> (1-100)	Defines the range level between light values and dark values. As the value increases, the separation between light and dark becomes more obvious.
<b>Saturation</b> (1-100)	Defines the level of the actual color intensity. As it increases, colors appear more pure; as it decreases, colors appear more gray-out.
<b>Hue(1-100)</b>	It is the term used to refer to the pure spectrum colors. Adjust this value to find the color closest to the real scene.
<b>Line Frequency</b> (50Hz / 60 Hz)	The function that adjusts the shutter speed options to match the frequencies of artificial light source of given country. For example, in Europe, the light frequency is 50Hz (due to power supply frequency of lights), that is 50 flashes per second. By setting line frequency to 50Hz in such case, the shutter speed options will be proportional with light source frequency, such as 1/25s, 1/50s, 1/100s, etc. It is necessary to have the camera's line frequency adjusted according to the power frequency of the light source to avoid flickering effect.

## Configure PTZ Devices

PTZ devices can do panning, tilting and zooming automatically or through manipulation. The PTZ-related applications are broadly supported by ENR. For example, you may control the movements of a PTZ camera with user interface panel controls or a joystick; the device can be programmed to execute a continuous tour or triggered by events to go to a preset position.

**By default, ENR will communicate ACTi devices with the default settings, in which case you will not need to configure any property.** For certain PTZ solutions, such as a hemispheric camera in 6VGA mode or an analog PTZ device attached to an ACTi video server, you will need to enable the PTZ properties on ENR interface.

Brand	PTZ Device Types	Requires enabling of PTZ on ENR interface
ACTi	IP Speed Dome	
	IP Zoom Camera / IP PTZ Camera	
	Hemispheric / Fisheye Dome	V
	IP Camera mounted on Scanner/ Analog PTZ camera attached to Video Server	V
Others	All devices with PTZ functions	V

- To enable PTZ function on ENR interface:

Go to **Setup** page → **Camera** tab, select the device from **Camera List**, click , check **“Enable PTZ”**, and then click **“Apply”**.

- To enable an analog camera attached to video server:

- Configure the parameters (e.g. Vendor, Protocol, Baud rate, Address ID) on physical device according to the product's installation instructions. On the device's (camera or video server) web configurator, configure the parameters to match the setting on physical device, and test the PTZ operations to make sure the device is properly set to be connected with.
- On ENR interface go to **Setup** page → **Camera** tab, select the device from **Camera List**, click , check **“Enable PTZ”**, configure the settings to ensure that they match those on the physical devices and the web configurator, and then click **“Apply”**.



The screenshot displays the system administrator interface with a top navigation bar containing icons for System, Network, Camera, Schedule, Event, Log, User, Maintenance, Power, and a close button. A 'Get Camera Settings' button is visible. The main area shows a list of cameras on the left, with '02 PTZ' selected. A 'PTZ Protocol' dialog box is open, containing the following fields:

- Enable PTZ
- Vendor: DYNACOLOR
- Protocol: DYNACOLOR
- Parity: 8N1
- Baudrate: 9600
- Address ID: 1

At the bottom of the dialog box, there are 'Apply' and 'Close' buttons. The 'Apply' button is highlighted with a red box and a red circle containing the number 3. A red circle containing the number 2 is positioned near the 'Enable PTZ' checkbox. In the top right corner of the interface, a red circle containing the number 1 is positioned near the 'PTZ' tab.

## Open PTZ Panel



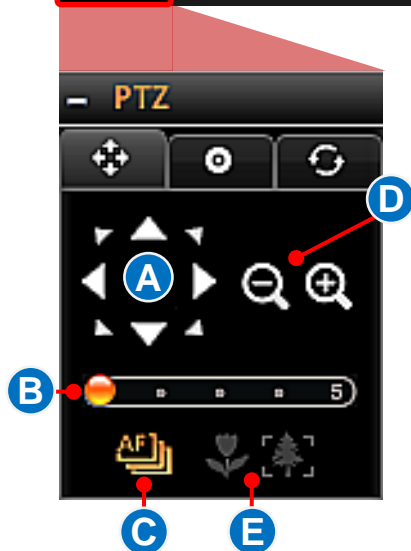
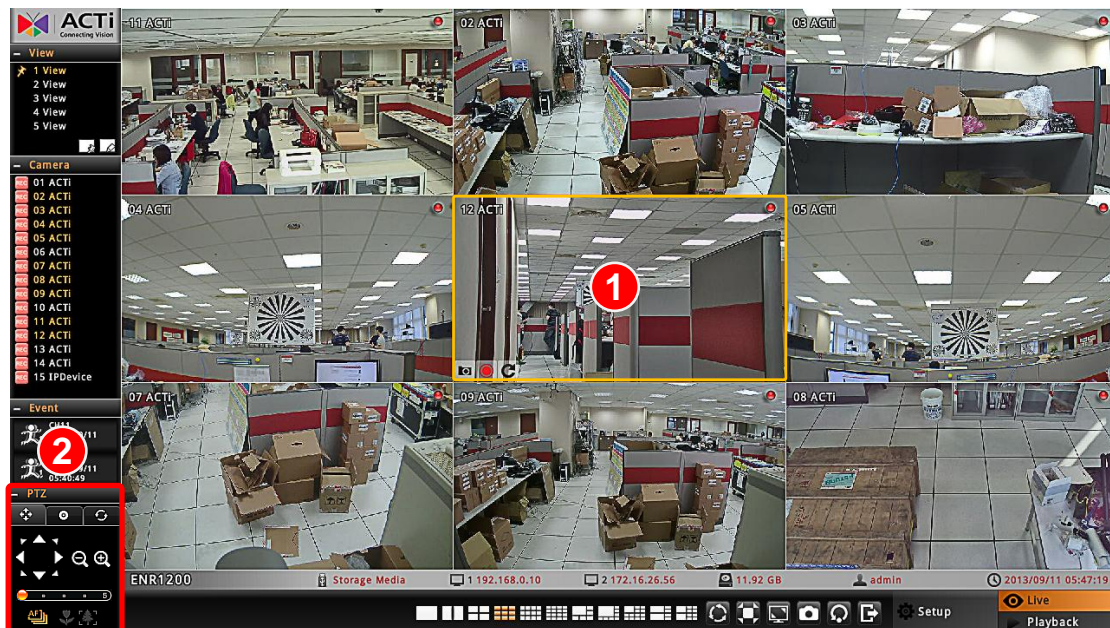

With PTZ cameras, you may define a view by where to look (through panning and tilting) and how close (through zooming) to zoom. Once these views have been saved in ENR as preset points, the device can always point to this view upon the event triggering or user's command. For local operation, the PTZ-related configurations are done on **Live** screen. Please note that, the PTZ-related settings you configure here will overwrite those on camera's firmware.

On **Live** screen, select a PTZ channel, the PTZ panel will become enabled.



## Manipulate PTZ Movements

Click the tab  to enter PTZ operation mode, and make use of the device's PTZ capabilities to define a view.

No	Function
A	<b>Eight-direction arrow keys</b> Click to pan or tilt the camera (only available for camera with Pan/Tilt/ capability).
B	<b>Pan/Tilt/Zoom speed</b> Click to change the speed. Provided speed scale is from 1 to 5 (available for cameras with Pan/Tilt/Zoom capability).
C	<b>Auto focus</b> (available for cameras with auto focus capability)
D	<b>Zoom</b> (Available for cameras with a controllable zoom)  Zoom in  Zoom out
E	<b>Manual focus</b> (Available for cameras with a controllable focus)  Near focus  Far focus These buttons are enabled when the "Auto Focus" is disabled.

## Go to Preset Points



You may create/delete/go-to preset points in this mode.

### Go to a Preset Point

Click the tab  to enter **Preset Points Operation** mode, and click a red ID button.



### Create a Presset Point

1. Go to **PTZ Operation** mode , use onscreen buttons to define a view.
2. Click the tab  to enter **Preset Points Operation** mode.
3. Click .
4. Click the desired preset point **ID** and input the point name in **Preset Point Setting** box.

This preset point will be saved, and its ID will turn red.

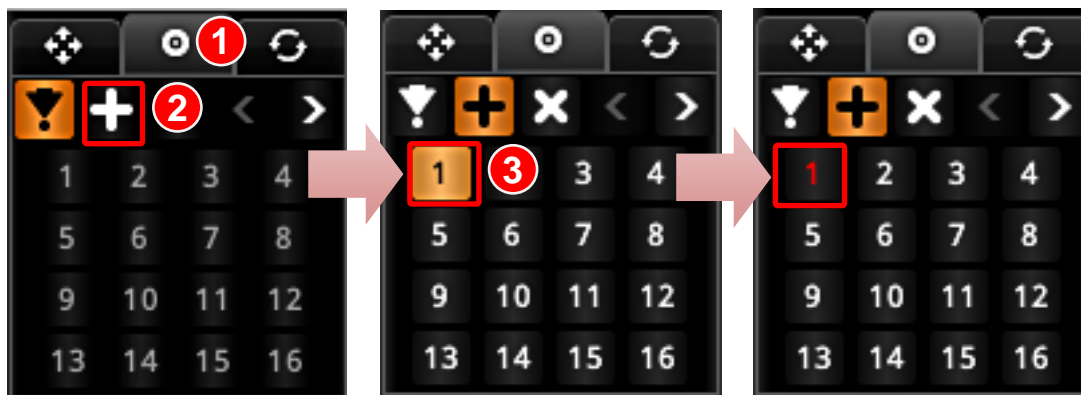

### Delete a Presset Point





On **Preset Points Operation** mode, click  and then the preset point you want to delete.



## Edit PTZ Preset Tour

Preset Tour is a preconfigured PTZ sequence that directs the camera to cycle through multiple preset points, including where to look and how long to look at each location. With this preset tour, your PTZ device can perform an automatic patrol to scan through your cared areas.

Before setting up **Preset Tours**, please make sure you have set PTZ Preset Points. To start:

1. On **PTZ Panel**, click  and then  to enter Tour edit window.
2. On **Tour Setting** window, select a **Tour** from drop-down list.
3. Select a **Preset Point** from drop-down list.
4. Set the **Dwell Time**, default is 10 seconds.
5. Click  to save this point into the list.
6. Repeat **step 1 ~ step 5** to add other points in your desired movement sequence. You may use the edit buttons to change the point order or delete a point. Click **"Save"** when this Tour list is well set. Click **"Close"** to exit this window.
7. The ID of a saved tour will appear red. Click on it to start the tour, and click  to stop it.

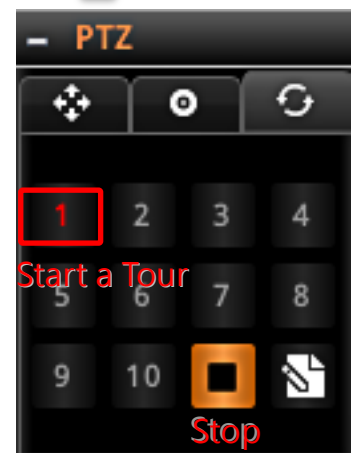
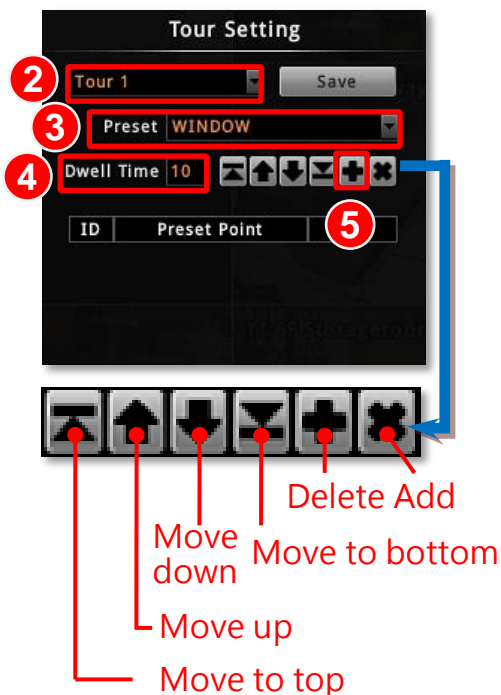

## Device Information

To change the device name, check firmware version information or Mac address, please go to **Setup** page → **System** tab → **Network**

After modifying the **System Name**, click “**Save**” to save the settings.

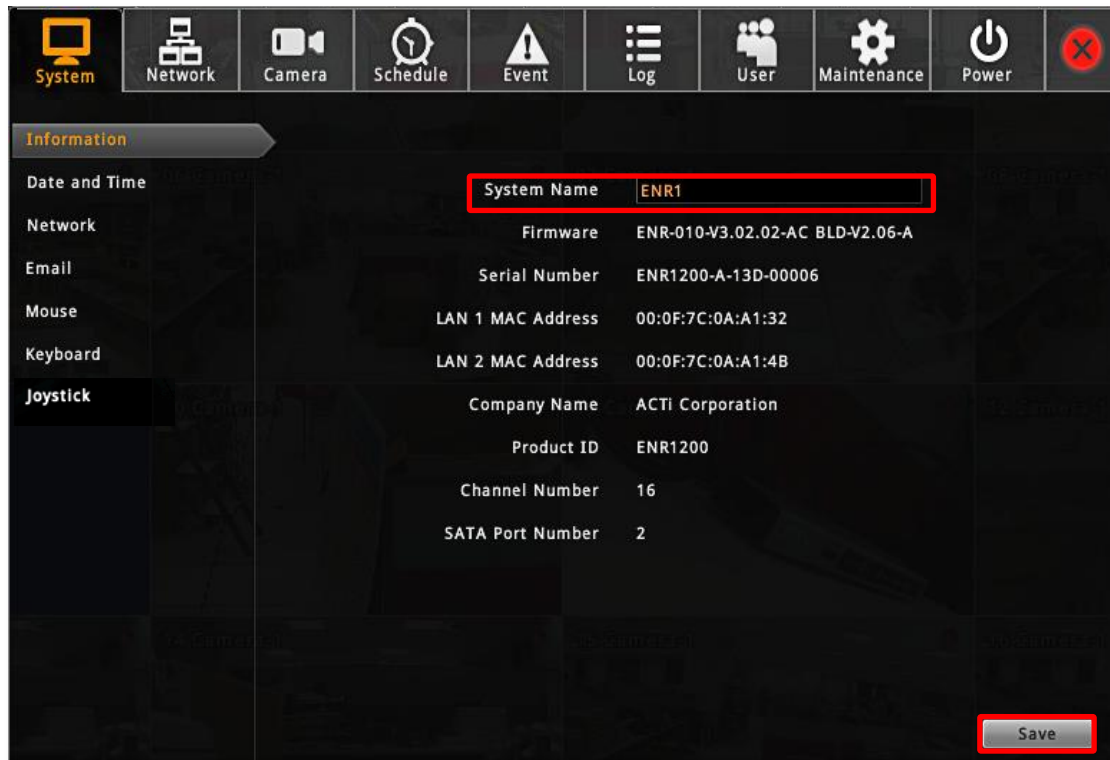

## Network Settings



There are two network interface cards in ENR. Either of these cards can be supported by the built-in DHCP server feature, which enables ENR to assign IP addresses to cameras via **LAN1** or **LAN2** port without another DHCP on router.

Go to **Setup** page → **Network** tab

The current settings of both LANs will be displayed here.

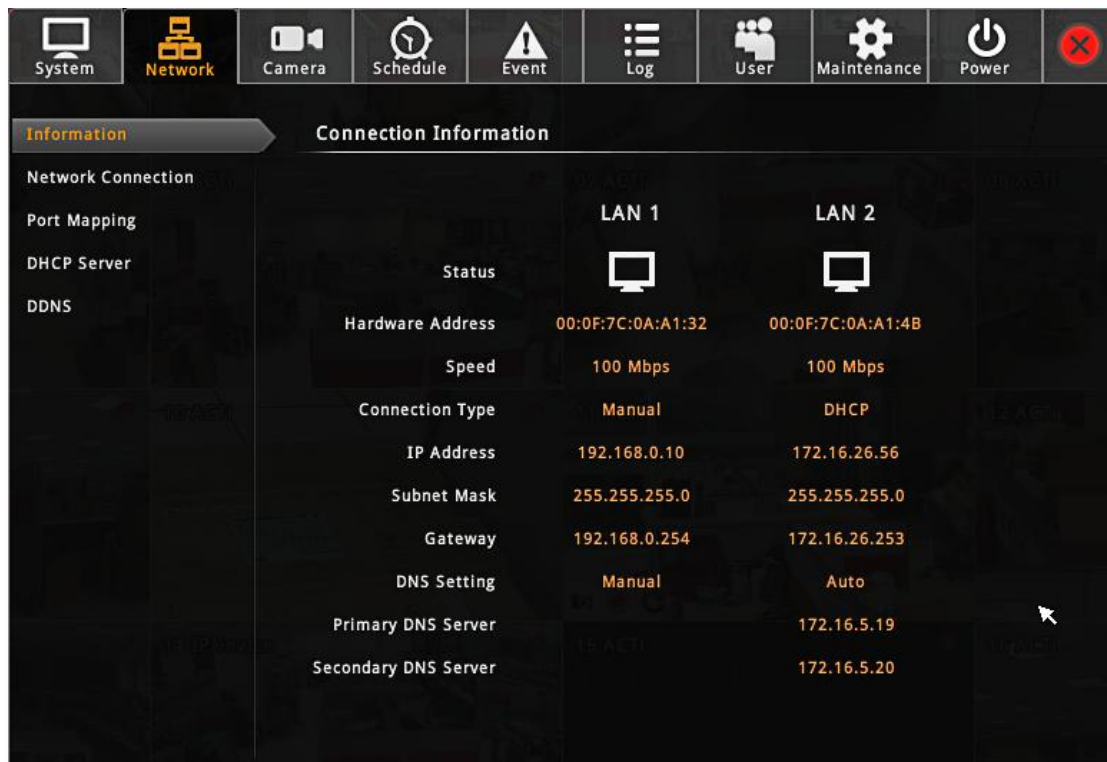
By default, **LAN1** card is set to **Manual** mode with a fixed IP address **192.168.0.10**, while **LAN2** is in **DHCP** client mode. It is suggested that you connect **LAN1** to LAN and connect **LAN2** to WAN.



Information		Connection Information	
Network Connection		LAN 1	LAN 2
Port Mapping	Status		
DHCP Server	Hardware Address	00:0F:7C:0A:A1:32	00:0F:7C:0A:A1:4B
DDNS	Speed	100 Mbps	100 Mbps
	Connection Type	Manual	DHCP
	IP Address	192.168.0.10	172.16.26.56
	Subnet Mask	255.255.255.0	255.255.255.0
	Gateway	192.168.0.254	172.16.26.253
	DNS Setting	Manual	Auto
	Primary DNS Server		172.16.5.19
	Secondary DNS Server		172.16.5.20



## IP Settings

Go to **Setup** page → **Network** tab → click “**Network Connection**” and select the **LAN** interface card that you wish to set up. After setting up, please click “**Save**” on the bottom right to save the settings.

### LAN Connection Status

Shows “**Activated**” when connected to a network.

Shows “**Detected Network Cable Disconnection**” when not connected to a network

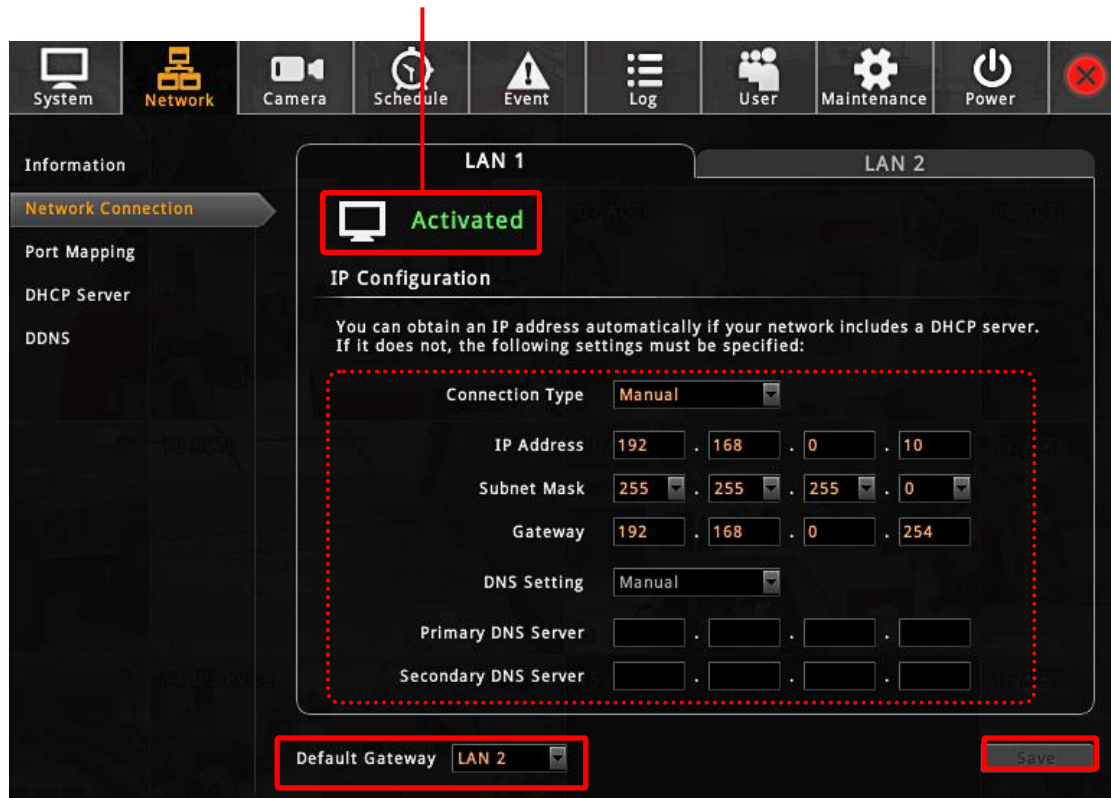

Field Name	Description
<b>Connection Type</b>	<p>Choose one connection type for this LAN port. DHCP and PPPoE service will assign an IP Address to ENR, and there is no need for you to define other network information.</p> <p><b>Manual:</b> Please obtain a static IP address and other network information including Subnet Mask, Gateway and DNS server from your network administrator.</p> <p><b>DHCP:</b> Use this connection type if you have a DHCP server on your network router.</p> <p><b>PPPoE:</b> Chose this when your ISP is using PPPoE type DSL line. Please contact you ISP to get the <b>Username</b> and <b>Password</b> for this connection.</p> <p><b>LAN1</b> default is <i>Manual</i>; <b>LAN2</b> default is <i>DHCP</i>.</p>
<b>IP Address</b>	<p>Fixed IP Address. <b>LAN1</b> default is <i>192.168.0.10</i>; <b>LAN2</b> default is <i>Auto</i>.</p>

<b>Subnet Mask</b>	Used to define if the destination is in the same subnet. <b>LAN1</b> default is <i>255.255.255.0</i> ; <b>LAN2</b> default is <i>Auto</i> .
<b>Gateway</b>	A valid gateway setting is essential for data transmission between different subnets, such as accessing the DNS service or SMTP server on the Internet. <b>LAN1</b> default is <i>192.168.0.254</i> ; <b>LAN2</b> default is <i>Auto</i> .
<b>DNS Setting</b> <b>Primary DNS Server</b> <b>Secondary DNS Server</b>	The DNS server that translates domain names to actual IP addresses. If this LAN is <b>Manual</b> mode, and you will set an SMTP server for event notification, be sure to set the Primary DNS and Secondary DNS. <b>LAN1</b> default is <i>Manual</i> ; <b>LAN2</b> default is <i>Auto</i> .
<b>Default Gateway</b>	Choose the gateway of the LAN card whose network is to connect with Internet. Default uses <i>LAN2's setting</i> .

### Change Port Setting

The default connection port used for remote web client to communicate with ENR is **80**. To change it, click "**Port Mapping**" to modify and save the setting.

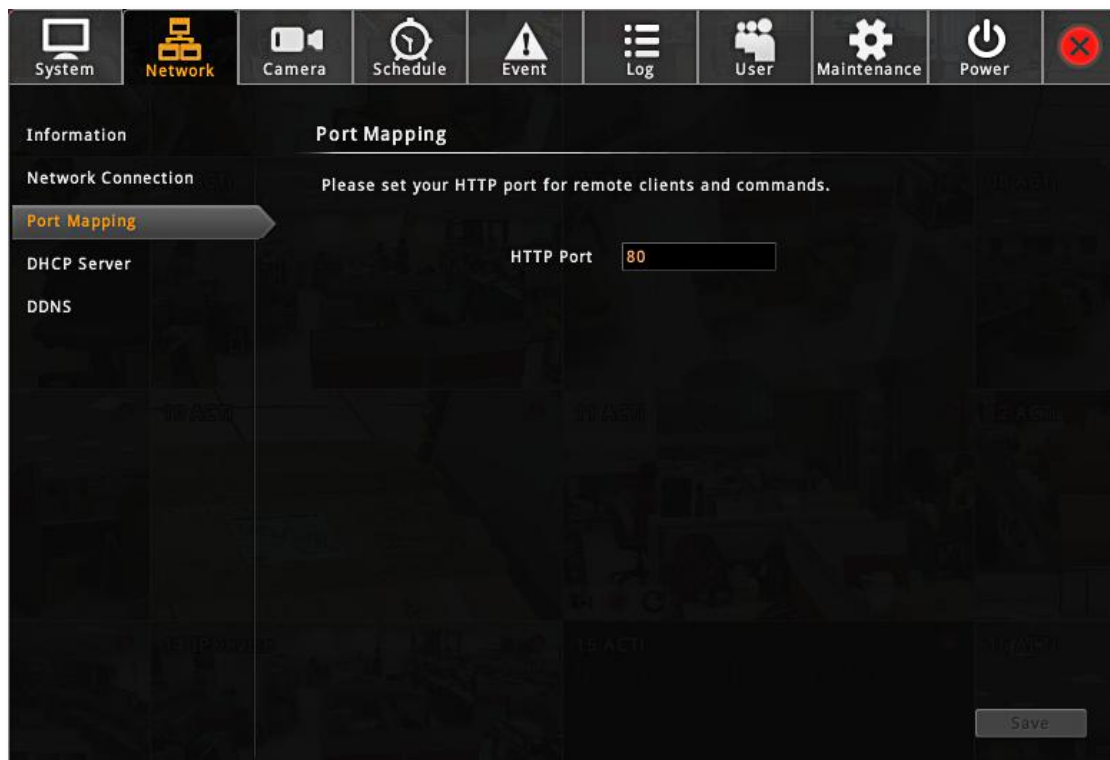

## Enable DHCP Server

You may enable the built-in DHCP server for either **LAN1** or **LAN2** port.

Go to **Setup** page → **Network** tab → click “**DHCP Server**”:

1. Check “**Enable**” and select a LAN, this LAN has to be in **Manual** mode.
2. Set the **Beginning IP Address** and **Ending Address**, and click “**Save**”. ENR will assign

IP addresses within this range to the cameras connected to the selected LAN port. Please (1) make sure the cameras are in DHCP client mode, (2) connect and power the cameras up after you enable this service.



## Enable DDNS Service

ENR has built-in the DDNS update client feature, which saves ENR domain name address information and actively update its ip address to the DDNS provider's server.

1. Visit the dynamic DNS service provider's website and register the domain name for your ENR.

ENR supports the following service providers:

- DynDNS: <http://www.dyndns.com>
- NO-IP: <http://www.noip.com/>

2. Go to **Setup** page → **Network** tab → click "**DDNS**".
3. Check "**Enable**", select the service provider, and input the **Host Name**, **User Name** and Password.
4. Click "**Save**" to save the settings.

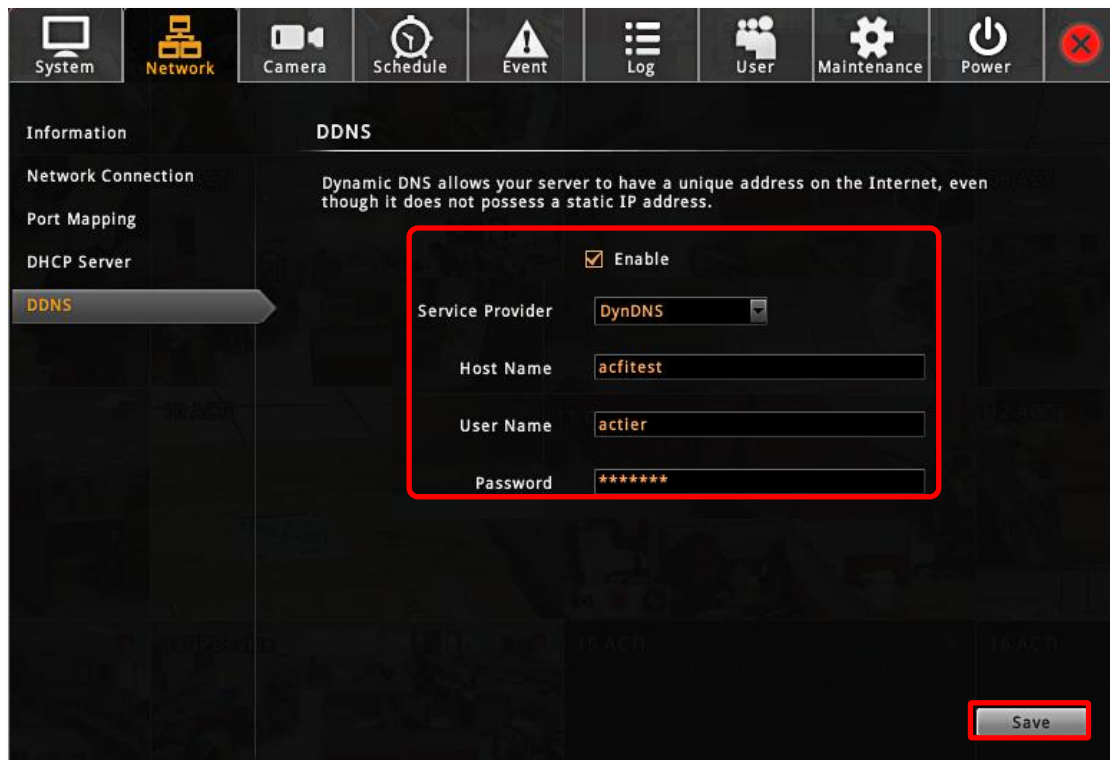

Information

Network Connection

Port Mapping

DHCP Server

**DDNS**

**DDNS**

Dynamic DNS allows your server to have a unique address on the Internet, even though it does not possess a static IP address.

Enable

Service Provider: DynDNS

Host Name: acfitest

User Name: actier

Password: \*\*\*\*\*

Save

## Date & Time

ENR provides three methods to synchronize the time setting; you can (1) manually set the date and time, (2) sync with Time Zone or (3) synchronize with NTP server.

On **Live** screen, click **Setup** → click **System** tab → click “**Date and Time**”

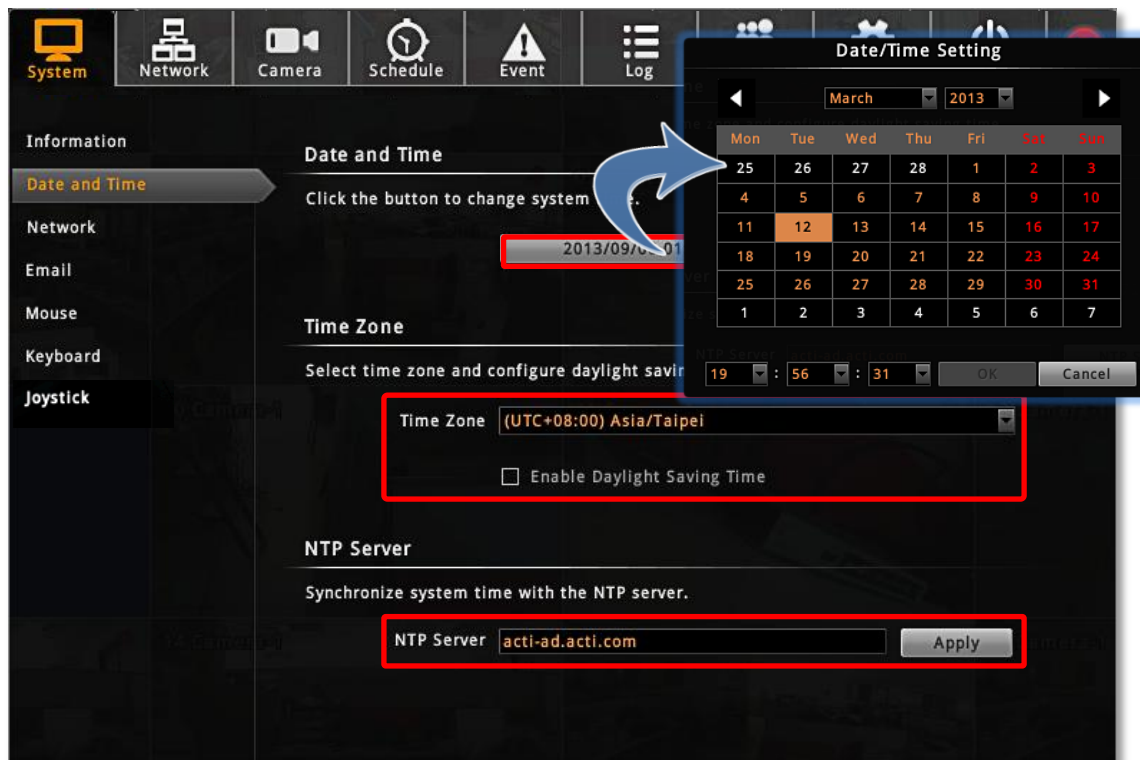

### Setup Manually

In **Date & Time** section, click the button that shows date and time information on it. On the popped-out calendar, select the correct date and time, then click “**OK**”.

### Synchronize with Time Zone

In **Time Zone** section, select your zone from the **Time Zone** drop-down list. If your time zone falls in Daylight Saving Time area, you may check the box “**Enable Daylight Saving Time**”, and then system time will automatically adapt itself to daylight saving time clock.

### Synchronize with NTP server

In **NTP Server** section, fill in the NTP server IP or domain name in the NTP Server field, and click “**Apply**” to start synchronizing.

## E-mail Settings

ENR supports e-mail notification for **Event Handling** sent through an SMTP server. To enable this service, you will have to configure the SMTP mail settings in advance. For SMTP service, please go to **Setup** page → **System** tab → **Network** and make sure the **Default Gateway** adopts the setting of the LAN connection has access to the SMTP server.

1. On **Live** screen, click **Setup** → Select **System** tab → click “**Email**”.

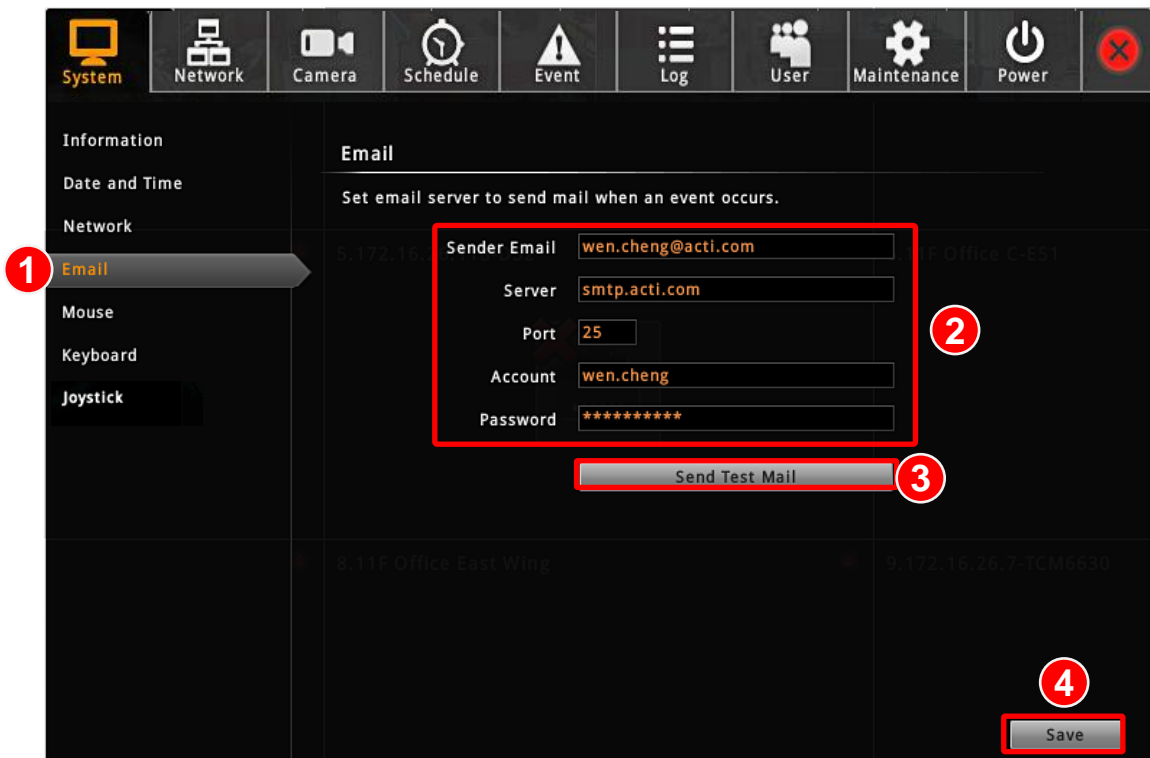

2. Fill in **every field** according to the detailed instructions in the table below.
3. Click “**Send Test Mail**” to send a test mail to this e-mail account. If the test mail is sent successfully, the dialog box below will pop up, which means your ENR server is ready to send out e-mail notifications when being triggered by an event.

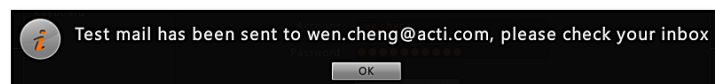

4. Click “**Save**” to save these properties.

Field Name	Description
<b>Sender Email</b>	Input the sender's e-mail address, should the same account you set for SMTP server.
<b>Server</b>	Input the sender's SMTP server address. Only alphabets, numbers, and the

	symbols (.), ( _), (-) are valid. ENR server <u>supports the SMTP services with SSL protocol</u> . If you wish to use a free webmail SMTP service, you may choose certain webmail providers such as <b>Yahoo</b> (SMTP: smtp.mail.yahoo.com Port:25) or <b>Gmail</b> (SMTP: smtp.gmail.com Port:25 or 465 for SSL protocol / 587 for TLS protocol)
<b>Port</b>	Set the SMTP port, allowed value is from 1~65535, default is <b>25</b> .
<b>Account</b>	Input the name of the SMTP server account. The form of account name depends on mail server, e.g. a Hotmail account name is a complete e-mail address, while other mail servers' are not. Only alphabets, numbers, and the symbols (@), (.), ( _), (-) are valid.
<b>Password</b>	Input the password of the SMTP server account. Only alphabets and numbers are valid.

## Disk Management

ENR keeps the recordings on SATA hard disks installed in it. Whenever recording is taking place, ENR writes data to one of the disks, and switch to the other as the original one is full. Once the available space of the whole system is less than the reserved size, ENR will start deleting the oldest file to make the amount of space allowing each active channel to record for another 10 minutes.

You may observe the disk memory and recording status on **Storage** page.

On **Live** screen, click **Setup** → click **System** tab → click “**Storage**”. The connected storage devices will be shown in the **Storage Device** list. Select a storage device to check its **Storage** Information appearing as below.

### Storage Device Types

- **SATA1** represents the disk installed in upper bay for saving recordings.
- **SATA2** represents the disk installed in lower bay for saving recordings.
- **Storage Media** represents the connected USB disk that you inserted for carrying firmware image file, backup file, exported system log file, snapshots or video.

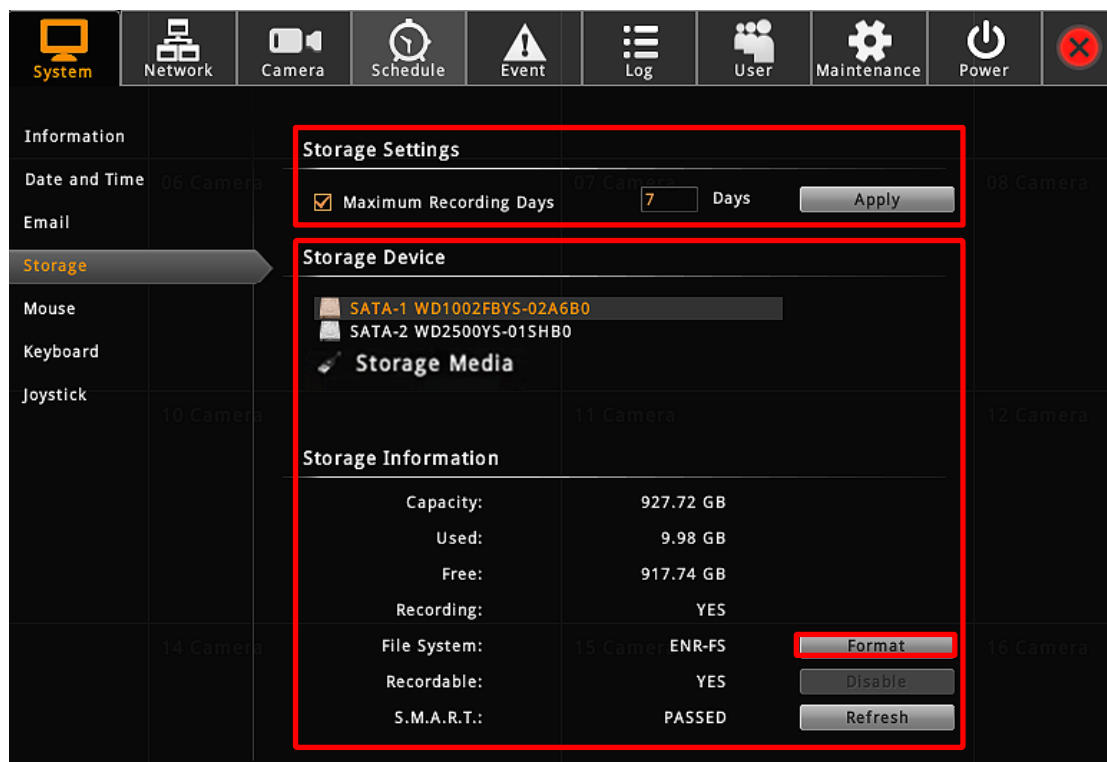

The screenshot displays the 'Storage' configuration page. The 'Storage Settings' section includes a checked option for 'Maximum Recording Days' set to 7. The 'Storage Device' section lists two SATA drives: 'SATA-1 WD1002FBYS-02A6B0' and 'SATA-2 WD2500YS-015HB0'. The 'Storage Information' section provides details for the selected drive: Capacity: 927.72 GB, Used: 9.98 GB, Free: 917.74 GB, Recording: YES, File System: ENR-FS, Recordable: YES, and S.M.A.R.T.: PASSED. A 'Format' button is highlighted in red.



## Format Hard Disks

Any newly-installed hard disk has to be formatted into ENR file system format. Click “**Format**” to start formatting a new disk. After formatting, this disk will become ready for recording.

During normal operation, **DO NOT REMOVE ANY DISK FROM THIS UNIT**, or it might cause damage to the disks. You can only remove or install a disk when the device is shut down.

Please note that the system will stop recording during the disk formation.

## Storage Settings - Set Recording Deletion Rule

In ENR system, there are two file-deletion mechanisms:

### 1. User defined - **Maximum Recording Days**

ENR can keep recording files for a certain number of days defined by you. Set this rule if you have more concern about how long the recordings are kept, especially when you do not want the old recordings to stay longer in the system than a certain period. By default, this rule is not activated, to modify it, check the box to input a number between **1~999** and click “**Apply**”.

### 2. Default - **Automatic Disk Deletion**

This is the default file deletion rule. When the total recordable disk space is full, an amount of disk space for approximate ten-minute long recording will be cleared to save new recordings.

If you activate the “**Maximum Recording Days**” rule, either of the thresholds reached earlier will execute the deletion first. Given that you set the **Maximum Recording Days** as **5 days**, the recording files that stay on the disks longer than this period will be deleted, despite that there is still plenty of available disk space; on the other hand, if your disk space is not enough to keep all the recordings for **5 days**, ENR will still delete the oldest files whenever the space is full.

Before setting up the rules, you can make use of a handy storage calculator provided by ACTi to find out the estimated storage your system requires: [http://www.acti.com/project\\_planner](http://www.acti.com/project_planner)

Also, be careful when you apply the **Maximum Recording Days** setting, for ENR will execute the deletion rule immediately whenever you click “**Apply**”, meaning that the all the recording files kept longer than the last applied number of maximum days are just deleted in no time.

## Check Disk Status

Hard disk failure often comes after detectable signs and thus can be predictable, thus it is important to detect these signs long before they really cause disk failures.

ENR performs **S.M.A.R.T.** Disk check on 24-hour basis since last check. This technology enables a system to monitor the disk status and anticipate disk failures, helping the system administrator to prevent from unexpected outage and data loss.

You may manually perform an instant **S.M.A.R.T** check by clicking “**Refresh**”.

Once the disk appears in “**WARNING**”, “**FAILED**”, or “**UNKNOWN**” status, it is not reliable for recording, and may fail when the number of bad sectors on the disk has grown high enough.



S.M.A.R.T Status	Description	Solution
<b>PASSED</b>	This disk is in normal condition.	--
<b>WARNING</b>	Certain error has been found on this disk.	<b>1.</b> On “ <b>Storage</b> ” page, select the disk and click “ <b>Disable</b> ” next to <b>Recordable</b> status to stop the system from saving recording into it.  <b>2.</b> Watch playback and export important video / system log.
<b>FAILED</b>	A number of errors have been found on this disk.	
<b>UNKNOWN</b>	Unable to get the disk information.	

### Manage Abnormal Disks

A disk that is not recognized as “**PASSED**” by **S.M.A.R.T.** check may have unexpected failures anytime. However, it will still continue recording until it finally fails.

After you disabled the recording on this disk and review important recordings,

1. Turn off the device.
2. Replace the abnormal disk with a new one, and turn on the device.
3. Go to **Live** screen, click **Setup** → click **Maintenance** tab → click “**Storage**”, and click “**Format**” to format the new disk.

## Schedule Recordings

Unlike the traditional analog surveillance system, the IP surveillance system provides a target-oriented recording schedule for devices; the view of each device can be recorded based on your required time segments and event types. For example, you may have a camera installed on the office ceiling do continuous recording during work hours, and record only upon the triggers (incidents that detected by system) at night. In this way, the system does not waste disk space storing meaningless parts, and you save lots of effort browsing playback for specific events.

For the recording schedule, ENR supports **Schedule recording**, **Event recording** and **Event Speed-up Recording** modes, which are set up on a week-based timetable; the event-handling schedule is configured here.

On ENR, you can configure camera's recording schedule on 7 days / 24 hours basis. The schedule is split into segments of one-hour-length. By default, once a device is added to the system, its schedule is automatically set to full-time schedule recording and event handling. You should configure it according to your system plan.

On **Live** screen → Select **Setup** → click "**Schedule**" tab and select one channel.

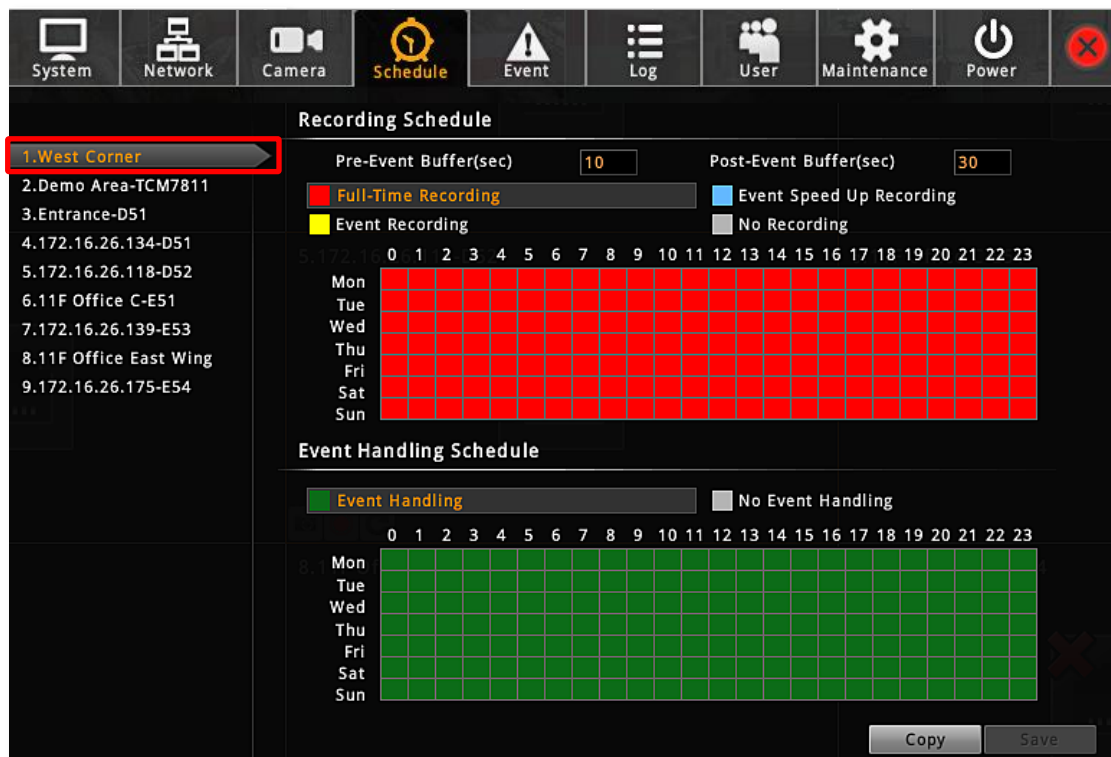

**Recording Schedule**

1. West Corner  
 2. Demo Area-TCM7811  
 3. Entrance-D51  
 4. 172.16.26.134-D51  
 5. 172.16.26.118-D52  
 6. 11F Office C-E51  
 7. 172.16.26.139-E53  
 8. 11F Office East Wing  
 9. 172.16.26.175-E54

Pre-Event Buffer(sec) 10 Post-Event Buffer(sec) 30

Full-Time Recording  Event Speed Up Recording  
 Event Recording  No Recording

	0	1	2	3	4	5	6	7	8	9	10	11	12	13	14	15	16	17	18	19	20	21	22	23
Mon	Red	Red	Red	Red	Red	Red	Red	Red	Red	Red	Red	Red	Red	Red	Red	Red	Red	Red	Red	Red	Red	Red	Red	Red
Tue	Red	Red	Red	Red	Red	Red	Red	Red	Red	Red	Red	Red	Red	Red	Red	Red	Red	Red	Red	Red	Red	Red	Red	Red
Wed	Red	Red	Red	Red	Red	Red	Red	Red	Red	Red	Red	Red	Red	Red	Red	Red	Red	Red	Red	Red	Red	Red	Red	Red
Thu	Red	Red	Red	Red	Red	Red	Red	Red	Red	Red	Red	Red	Red	Red	Red	Red	Red	Red	Red	Red	Red	Red	Red	Red
Fri	Red	Red	Red	Red	Red	Red	Red	Red	Red	Red	Red	Red	Red	Red	Red	Red	Red	Red	Red	Red	Red	Red	Red	Red
Sat	Red	Red	Red	Red	Red	Red	Red	Red	Red	Red	Red	Red	Red	Red	Red	Red	Red	Red	Red	Red	Red	Red	Red	Red
Sun	Red	Red	Red	Red	Red	Red	Red	Red	Red	Red	Red	Red	Red	Red	Red	Red	Red	Red	Red	Red	Red	Red	Red	Red

**Event Handling Schedule**

Event Handling  No Event Handling

	0	1	2	3	4	5	6	7	8	9	10	11	12	13	14	15	16	17	18	19	20	21	22	23
Mon	Green	Green	Green	Green	Green	Green	Green	Green	Green	Green	Green	Green	Green	Green	Green	Green	Green	Green	Green	Green	Green	Green	Green	Green
Tue	Green	Green	Green	Green	Green	Green	Green	Green	Green	Green	Green	Green	Green	Green	Green	Green	Green	Green	Green	Green	Green	Green	Green	Green
Wed	Green	Green	Green	Green	Green	Green	Green	Green	Green	Green	Green	Green	Green	Green	Green	Green	Green	Green	Green	Green	Green	Green	Green	Green
Thu	Green	Green	Green	Green	Green	Green	Green	Green	Green	Green	Green	Green	Green	Green	Green	Green	Green	Green	Green	Green	Green	Green	Green	Green
Fri	Green	Green	Green	Green	Green	Green	Green	Green	Green	Green	Green	Green	Green	Green	Green	Green	Green	Green	Green	Green	Green	Green	Green	Green
Sat	Green	Green	Green	Green	Green	Green	Green	Green	Green	Green	Green	Green	Green	Green	Green	Green	Green	Green	Green	Green	Green	Green	Green	Green
Sun	Green	Green	Green	Green	Green	Green	Green	Green	Green	Green	Green	Green	Green	Green	Green	Green	Green	Green	Green	Green	Green	Green	Green	Green

Copy Save

## Event-Recording File Length

Before setting the recording schedule, you may define the length of an event recording. To do this, configure the following properties shown as below, which will make an event recording as long as 10+30 second:

Recording Schedule	
Pre-Event Buffer(Sec)	<input type="text" value="10"/>
Post-Event Buffer(Sec)	<input type="text" value="30"/>

Field	Description
<b>Pre-event Recording Buffer (sec):</b>	ENR keeps a short cache of video received from devices. If an event is triggered, ENR will automatically store the pre-event buffer along with the recording of the event itself.
<b>Post-event Recording Buffer (sec):</b>	This will determine how long after the event is triggered should be included in the event recording file.

## Set the Recording Schedule

On the time table

- Click on the recording mode from

<input checked="" type="checkbox"/> Full-Time Recording	<input type="checkbox"/> Event Speed Up Recording
<input type="checkbox"/> Event Recording	<input type="checkbox"/> No Recording

Field	Description
<b>Full-Time Recording</b>	Continuously record at the video frame rate you define in <b>Camera Settings</b> .
<b>Event Speed Up Recording</b>	Continuously record everything at 1FPS, when an event occurs, the frame rate will switch to the value you define in <b>Camera Settings</b> , and automatically switch back to 1FPS after the event ends.
<b>Event Recording</b>	Only events are recorded, at the video frame rate you define in <b>Camera Settings</b> .

- Click and drag over the "Time Track" to set time period.

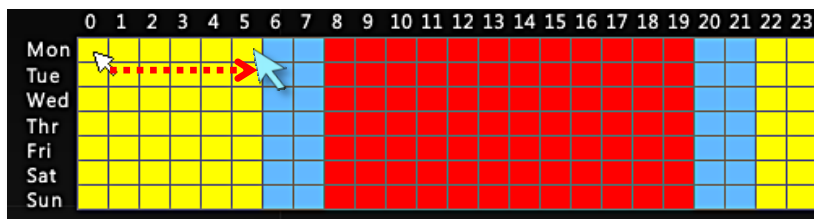

- Click "Save".

## Set the Event Schedule

The **Event Schedule** defines when the event handling is activated. To set the event rules, please refer to Set System Event Rules on page 68 for Event Rules settings. By default, the event handling is full-time activated; you may disable it during certain time period.

1. Click on the recording mode “**No Event Handling**”.
2. Click and drag over the “**Time Track**” to set time period.
3. Click “**Save**”.

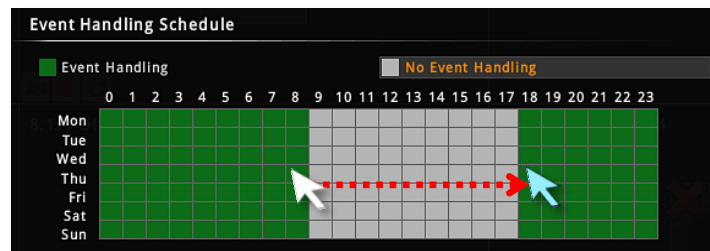

## Copy Schedule

You may copy a camera's schedule setting to other multiple cameras. This saves much your time on configuring the schedules camera by camera.

1. On **Schedule** tab, select a source camera from camera list, its schedule will be copied to others.
2. Click “**Copy**”
3. On **Copy Schedule** window, select the target cameras.
4. Click “**Copy**” on **Copy Schedule** window.

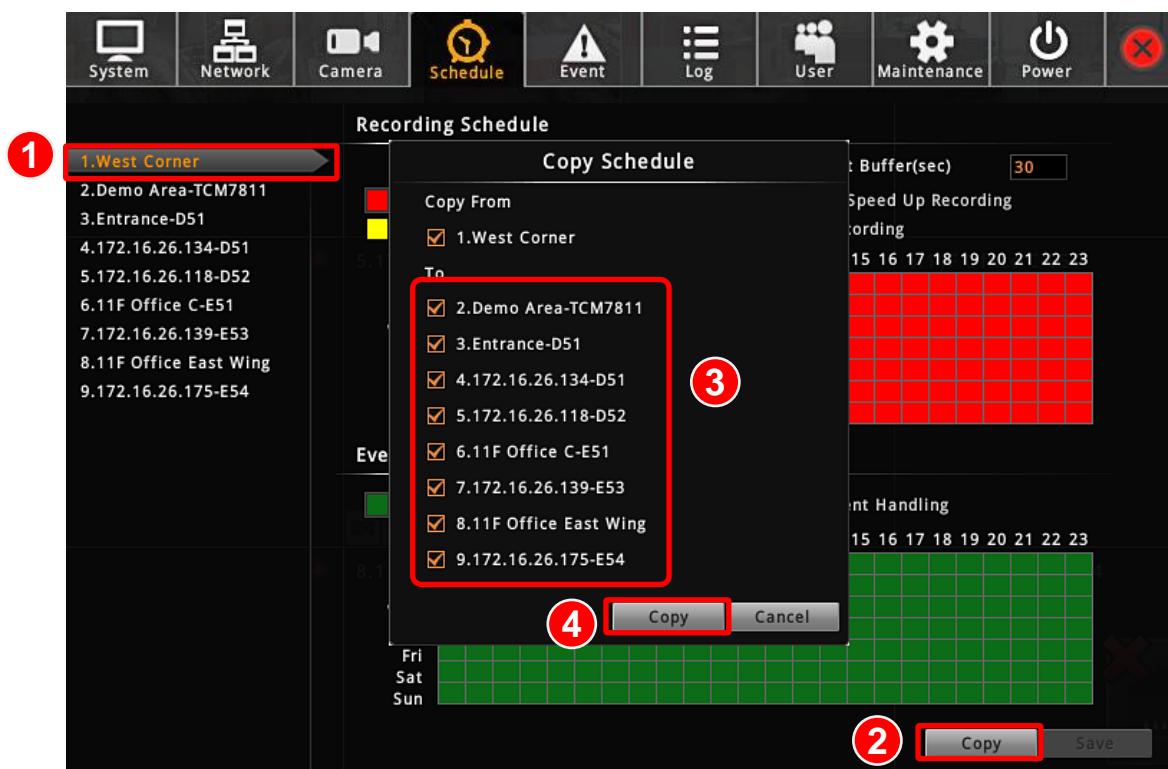

## Event Management

When something happens on camera site, such as someone walks by, the door opens or a fire breaks out – these are all **Events**. The event which occurs in the environment and was pre-programmed in the camera serves as **Triggers**. Triggers cause the device to react with **Responses**. The link between trigger and response is governed by **Event Rules**. Each event rule detects one specific trigger and may initiate multiple responses. An example rule would be for ENR to send an e-mail to alert the manager (**Response 1**) and trigger the alarm (**Response 2**) when motion on camera site is detected (**Trigger**) during the event handling active period (**Schedule**).

Each device can be involved in several event rules. As different camera models possess various capabilities, the supported response types would vary. For example, a PTZ camera can execute a go-to preset point response, while this option is not available for other models without this feature.

### Event-Handling Schedule

Event rules become active or inactive based upon a weekly schedule, to enable event-handling service, you will have to make sure the event-handling schedule of certain device is well configured. By default, the event-handling schedule of each camera is enabled for 24 hours once it is added to ENR system.

To configure the **Event Handling Schedule**, on **Live** screen, click **Setup** → click “**Schedule**”, select the camera, and drag on the 24-hour time table.

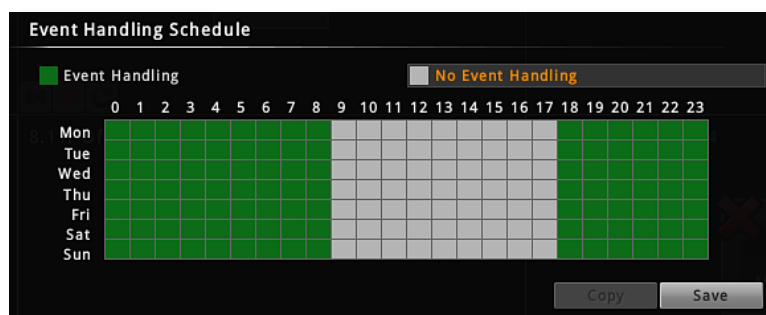

## Set System Event Rules

You can create event rules based on the abnormal condition occurring to ENR system.

On **Live** screen, click **Setup** → click **Event** tab → click **System Event**.

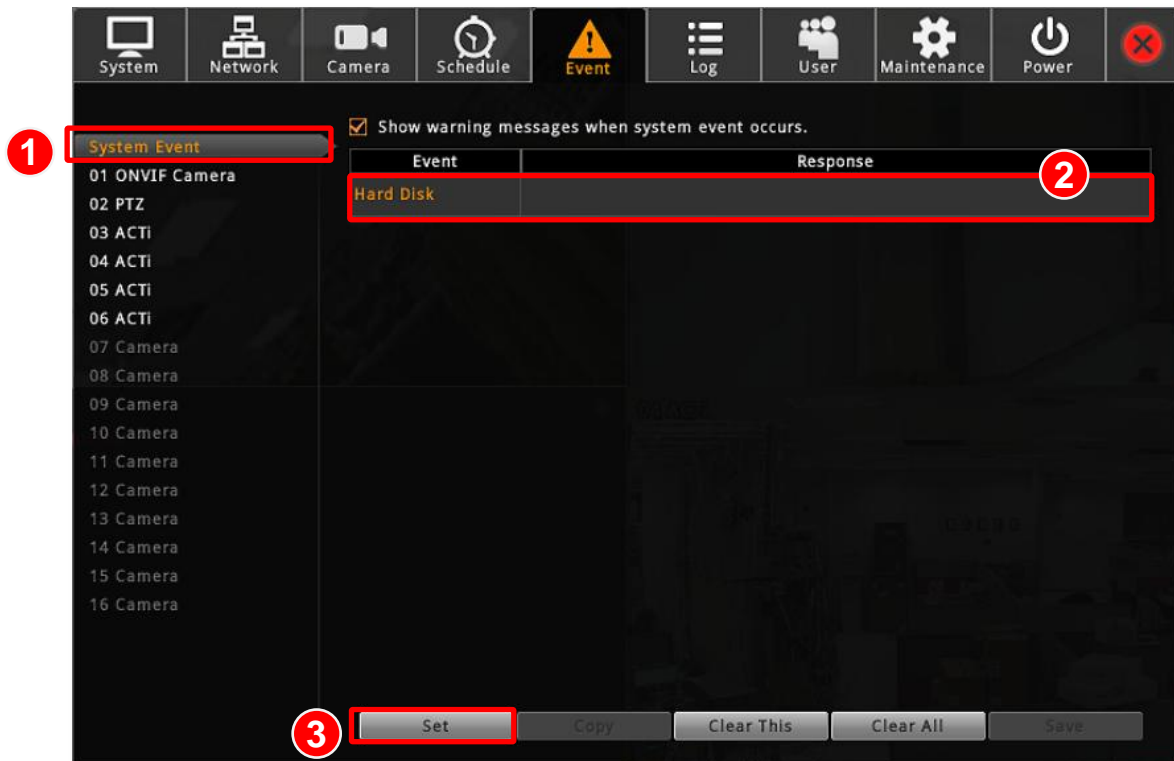

## Set Device Event Rules

On **Live** screen, click **Setup** → click **Event** tab → select a camera.

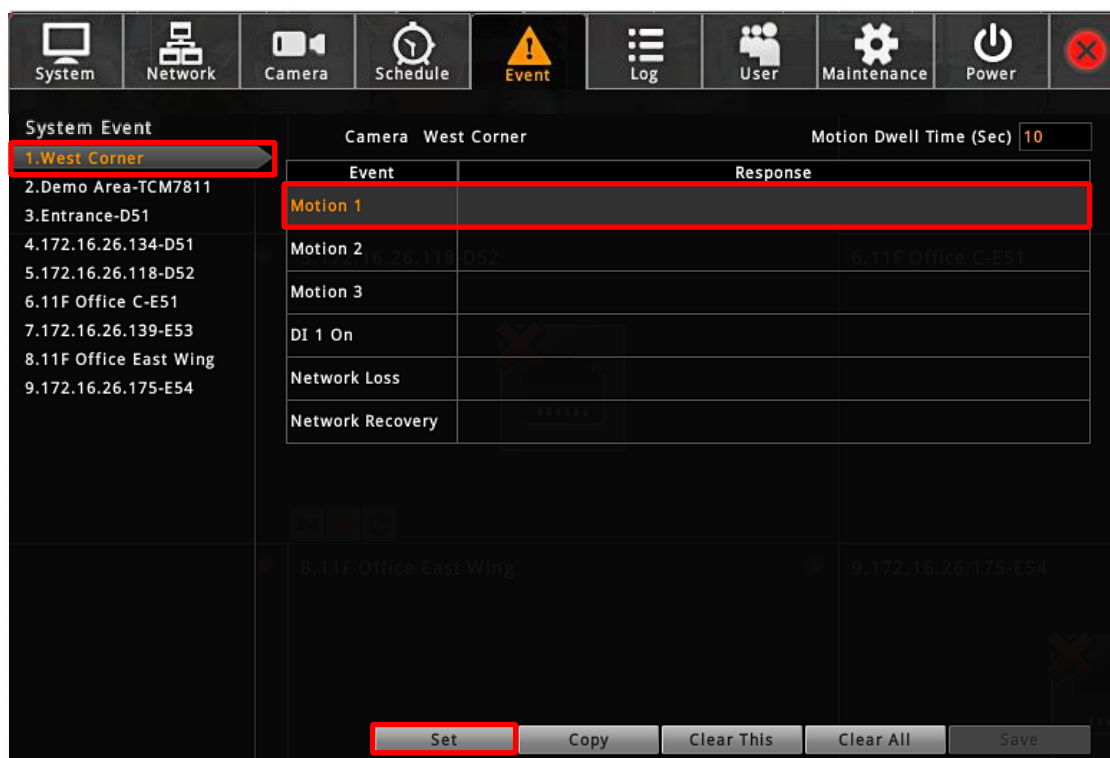



Once a device is added to ENR server, the server would provide empty rules with compatible trigger types for you to configure such as **Motion 1, Motion 2, Motion 3, DI 1, DI 2, Network Loss** and **Network Recovery**. Select the **Event Type**, then click “**Set**” to select the trigger types.

## Trigger Type

### ●Trigger DO

Set the DO to become ON or OFF upon trigger, only the devices supporting DO functions are available. Check the “**Enable**” to enable this function, and the device whose connected DO(s) will be triggered. You may select one DO to be activated after the other and the duration time between them. Click “**OK**” to confirm.



### ●Send Mail

Enable ENR to send e-mail notifications via SMTP service. Check the “**Enable**” to enable this function, and fill in the mail recipient’s e-mail address in “**To**” field, notification title in “**Subject**” field and mail body in “**Body**” field, then choose a camera whose snapshot will be attached from **Attach a Snapshot** dropdown list. Click “**OK**” to confirm. Please note that if you want to attach a snapshot to the notification e-mail, make sure your local display stays on **Live** screen during the event handling period, in this way, ENR can take the snapshots for motion events.

To enable this service, you have to configure the e-mail setting (please refer to [E-mail Settings](#) on page 58) before this trigger is enabled.

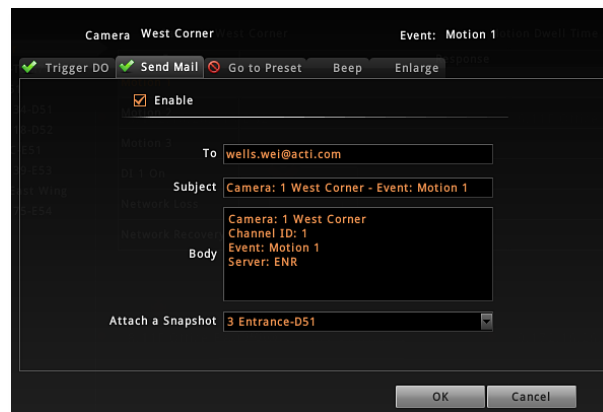

## ●Go to Preset

For the use of PTZ cameras to make movements toward certain triggers, please configure the preset points (refer to \_\_\_\_\_)

Go to Preset Points on page 49) on **Live** screen before you set the event rule.

On **Go to Preset** tab, check the “**Enable**” to enable this function (if there is no PTZ camera existing in ENR server to execute a PTZ response, a red sign would appear on the tab  **Go to Preset** , please add a PTZ camera). Select which PTZ camera in ENR server to make the movement, then the preset points and duration time between them. Click “**OK**” to confirm.

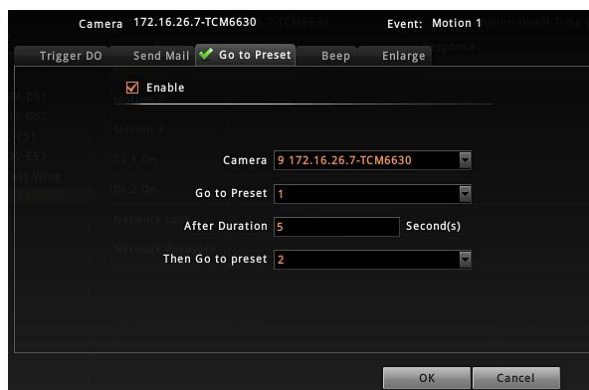

### ●Beep

**ENR** device can play beep sound upon being triggered by events. On **Beep** tab, check the “**Enable**” to enable this function. Input the duration time and repeat times of the beep. Click “**OK**” to confirm.

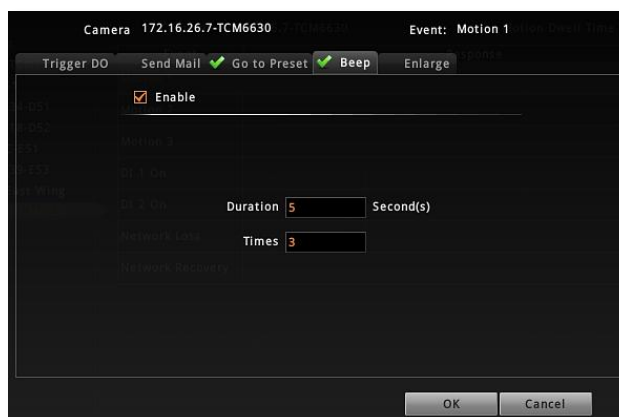

### ●Enlarge

**Live** screen will display certain channel view in full screen for a while when the system is triggered. On **Enlarge** tab, check the “**Enable**” to enable this function. Select the camera whose live view will be enlarged on **Live** screen and the duration time. Click “**OK**” to confirm.

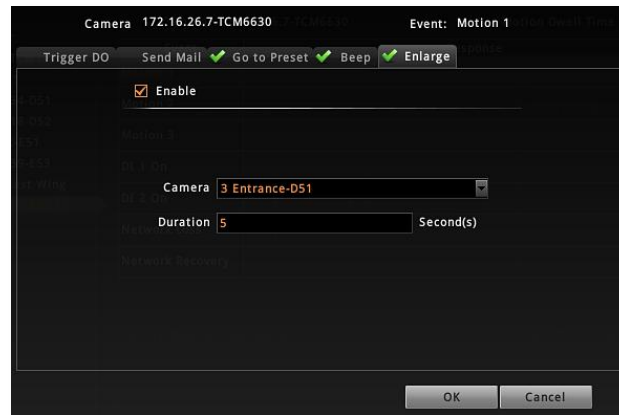

1. After configuring the event handling rules, on **Event** tab, input the dwell time in **Motion Dwell Time (sec) : 10** for all the rules you set. **Dwell Time** defines, after an event occurs, the period of time during which the same event will not be triggered again.
2. On **Event** tab, click "**Save**" to save the settings.

### Clear Event Rules

On **Event** tab, you may select an event rule under certain camera, and click "**Clear This**" to delete it, or "**Clear All**" to delete all the rules belong to this camera.

## Copy Event Rules

You may copy a camera's event rules to other multiple cameras. This saves much your time on setting up rules one by one.

1. On **Event** tab, select a source camera from camera list, its rules will be copied to others.
2. Click **“Copy”**
3. On **Copy Event** window, select the target cameras.
4. Click **“Copy”** on **Copy Event** window.

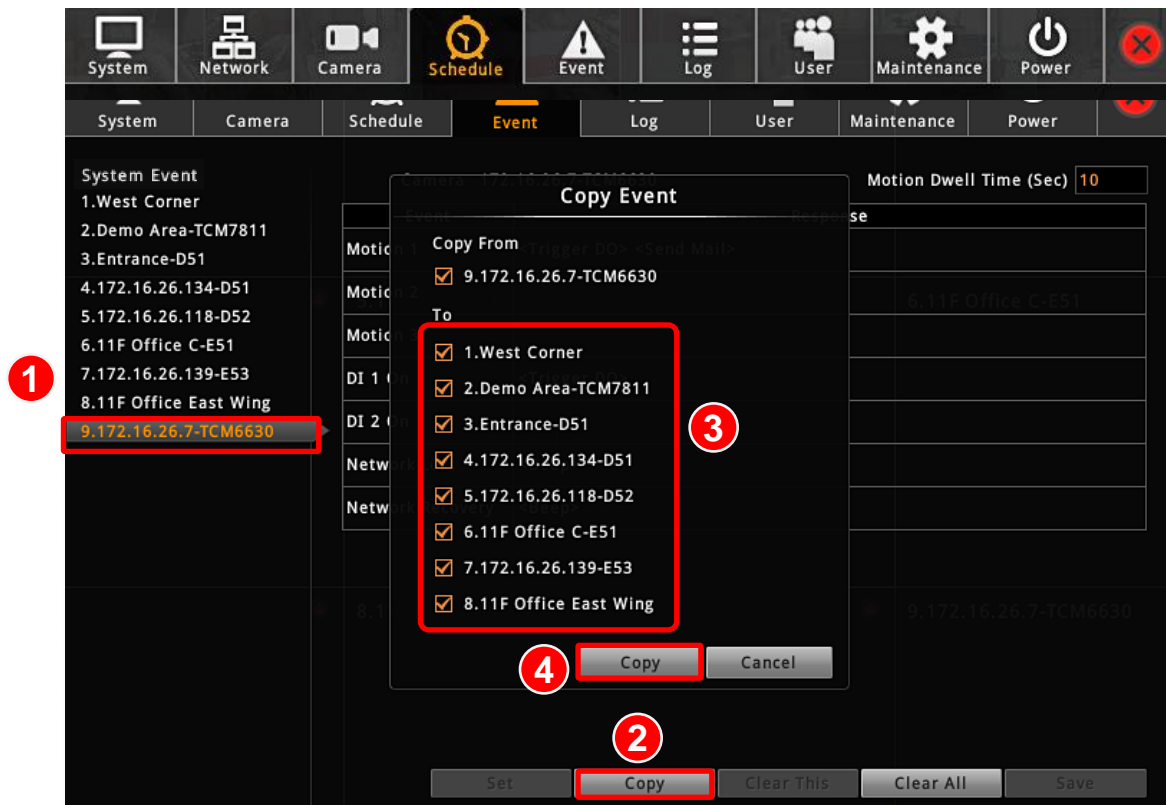

## Joystick

ENR supports two types of controller for local operations:

- **IP Desktop**, manufactured by *CH Products*
- **Extreme™ 3D Pro**, manufactured by *Logitech*

1. Connect the joystick to this unit.
2. Go to **Setup** page → **System** tab → **Joystick**.

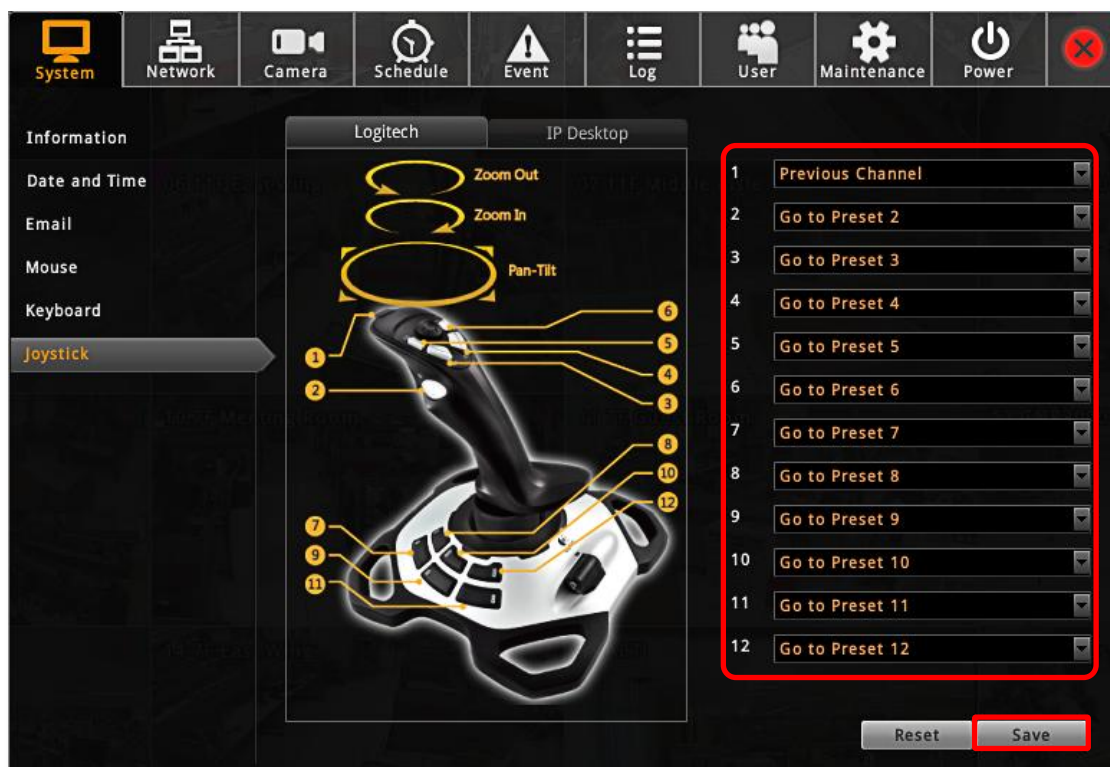

3. There are **12** buttons available on each controller; you may assign a function selected from dropdown list to any button. Every time you change the settings on this page, please click "**Save**" to save the settings of this joystick model.

## System Log

ENR records the important system activities and user's behaviors in **System Log**. Once the number of logs exceed **3000**, ENR will erase the earliest 100 logs.

On **Live** screen, click **Setup** → click **Log** tab

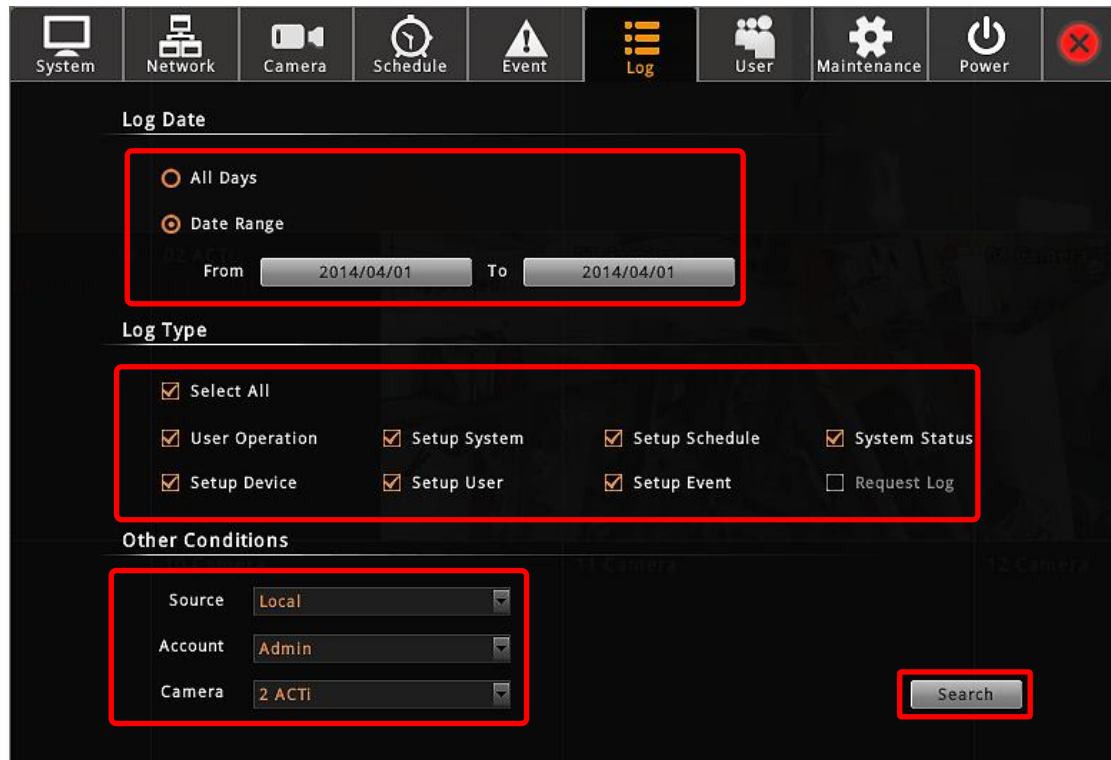

1. Define the time range:  
You may choose “**All Days**” to show all the logs or choose “**Day Range**” to specify a range.
2. Select **Log Types**

Log Types	Recorded Activities
<b>System Status</b>	System start up
<b>User Operation</b>	Login & logout
<b>Setup System</b>	Upgrade firmware, format storage backup / restore system configurations, reboot system, shutdown system, update time, update system information, update network settings, import/restore language file, update e-mail service configurations
<b>Setup Device</b>	Add camera, update camera, delete camera
<b>Setup Event</b>	Update event settings, update event handling schedule



<b>Setup User</b>	Update user, update user permissions
<b>Setup Schedule</b>	Update recording schedule, Update schedule settings

3. Define other conditions. For example, you can view the logs of all remote clients by selecting “**Remote**” for **Source**.
4. Click “**Search**” to start searching. will automatically refresh accordingly.

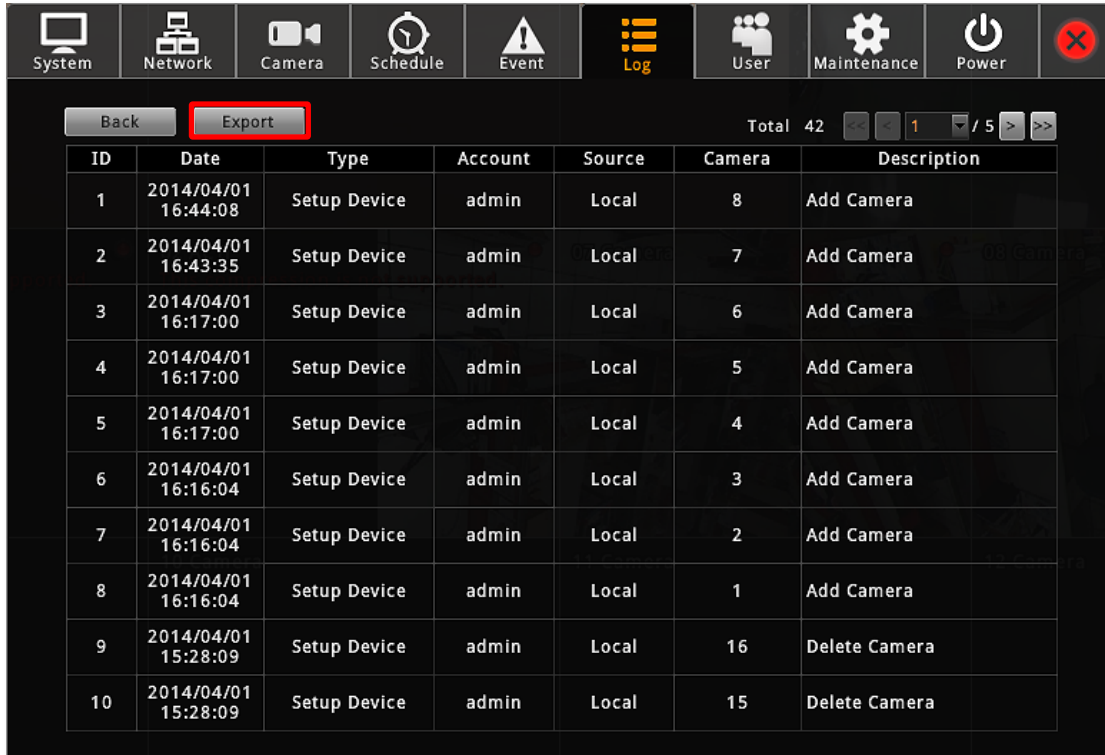

ID	Date	Type	Account	Source	Camera	Description
1	2014/04/01 16:44:08	Setup Device	admin	Local	8	Add Camera
2	2014/04/01 16:43:35	Setup Device	admin	Local	7	Add Camera
3	2014/04/01 16:17:00	Setup Device	admin	Local	6	Add Camera
4	2014/04/01 16:17:00	Setup Device	admin	Local	5	Add Camera
5	2014/04/01 16:17:00	Setup Device	admin	Local	4	Add Camera
6	2014/04/01 16:16:04	Setup Device	admin	Local	3	Add Camera
7	2014/04/01 16:16:04	Setup Device	admin	Local	2	Add Camera
8	2014/04/01 16:16:04	Setup Device	admin	Local	1	Add Camera
9	2014/04/01 15:28:09	Setup Device	admin	Local	16	Delete Camera
10	2014/04/01 15:28:09	Setup Device	admin	Local	15	Delete Camera

### Export System Log

To export the logs, insert a USB disk into ENR, click “**Export**” and save the xml file to your local computer. You may view this file on a computer with **Notepad** or **XML Editor**.

```
<?xml version="1.0"?>
- <Logs>
  <Log Source="Local" Account="admin" Date="2013/09/07 04:51:08" ID="1">Camera 9 is added</Log>
  <Log Source="Local" Account="admin" Date="2013/09/07 04:50:05" ID="2">Camera 9 is deleted</Log>
  <Log Source="Local" Account="admin" Date="2013/09/07 04:49:50" ID="3">Camera 9 is added</Log>
  <Log Source="Local" Account="admin" Date="2013/09/07 04:49:50" ID="4">Camera 3 is added</Log>
  <Log Source="Local" Account="admin" Date="2013/09/07 04:48:01" ID="5">Camera 9 is deleted</Log>
  <Log Source="Local" Account="admin" Date="2013/09/07 04:47:54" ID="6">Camera 3 is deleted</Log>
  <Log Source="Local" Account="admin" Date="2013/09/07 04:43:40" ID="7">Backup system configuration</Log>
  <Log Source="Local" Account="admin" Date="2013/09/07 00:48:40" ID="8">User login</Log>
  <Log Source="System" Account="*" Date="2013/09/07 00:44:13" ID="9">System start up</Log>
</Logs>
```

## User Group Management

In ENR, the access permissions are managed by **User Groups**. **User Groups** defines what functions are allowed for a group of users. Different **User Groups** will have different access rights in terms of permitted operations like monitoring **Live** screen or execute **Playback**. For example, an Administrator user is allowed for all the operations in ENR, while a standard normal user may only be permitted to do **Live** monitoring.

On **Live** screen, click **Setup** → click **User** tab to enter **Group** and **User** management page.

### Add a Group

By default, the **Administrator** User Group with full permissions in ENR already exists. Except for the password and e-mail settings, you may not delete this account or change its permissions.

1. Select "**Group**", click "**Add**" to bring up **Add New Group** window, enter the **Name** and **Description** of the group, and click "**OK**" to add it to the **Group List**.

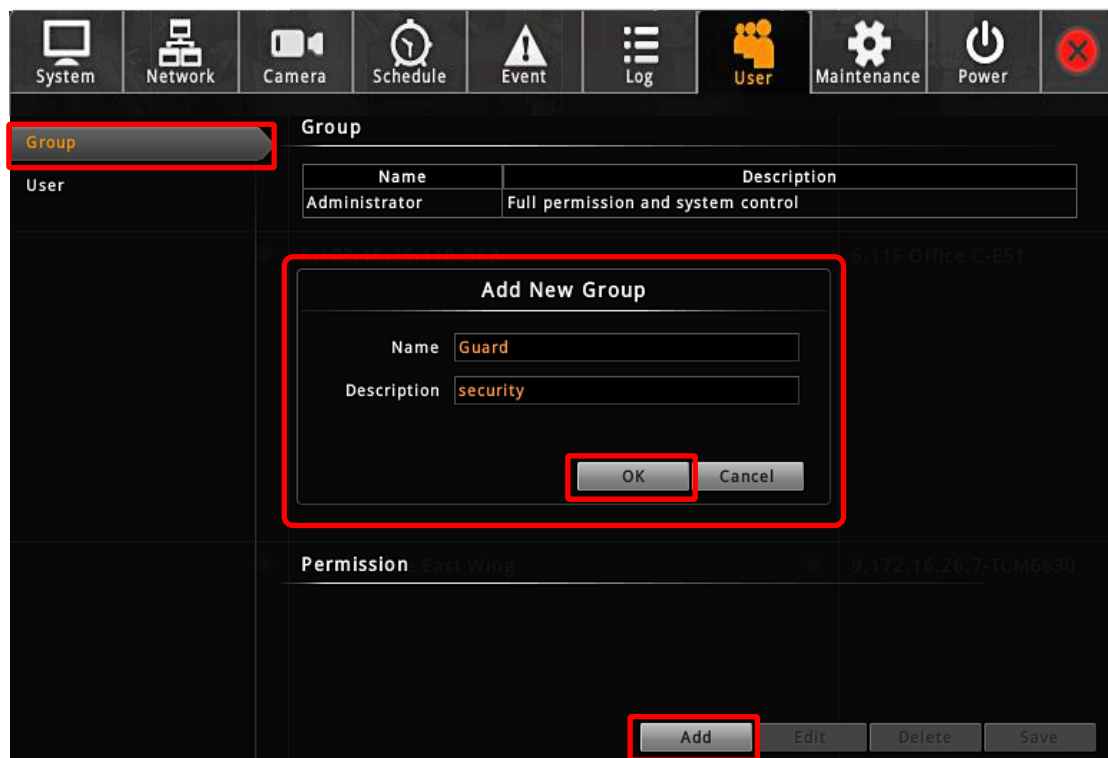

2. On **Group List**, select this group. In **Group Permission** section, enable the permissions possessed by this group.

3. Click “**Save**” to save the group settings.

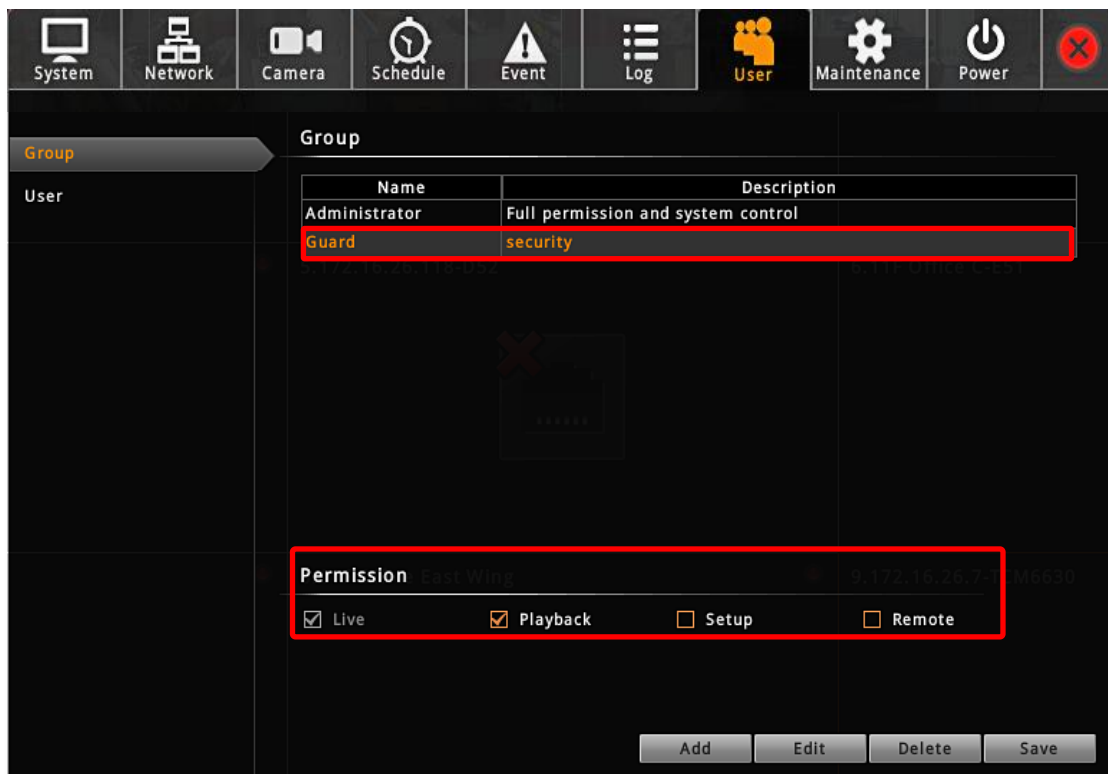

## Edit / Delete a Group

You may edit an existing group by changing its **Name**, **Description** or **Permissions** or delete it. Once you delete a group, the Users belonging to it will be removed altogether. Select the group on Group List, click “**Edit**” or **Delete**”.

## Add a User

By default, the **Administrator** User already exists, which you may not delete.

1. Select User, click “**Add**” to bring up **Add New User** window, enter the **Name**, **Password**, **Email** and select its **User Group** from dropdown list. Click “**OK**” to add it to the **User List**.
2. Click “**Save**” to save the user settings.

## Account /Password Rules

1. **Account** field allows alphabets, numbers, and symbols except the following: \* < > ? | “ \ : .  
The maximum length of characters is 15.
2. **Password** field allows alphabets, numbers and symbols. The maximum length of characters is 40.
3. Both the **Account** and **Password** field are non-case-sensitive.

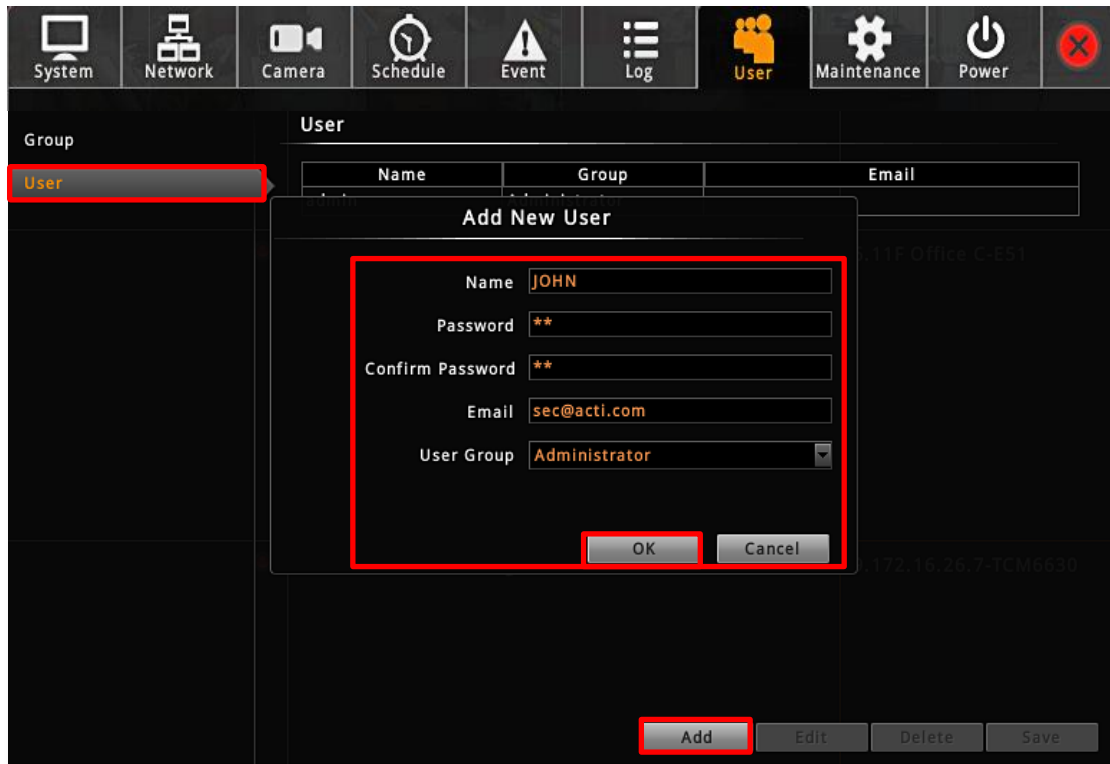

### Edit / Delete a User

You may edit an existing user or delete it. Select the user on **User List**, click **“Edit”** or **“Delete”**. Please always click **“Save”** before leaving this page.

## Upgrade Firmware

You may check ACTi corporate website for latest ENR firmware package and download it. Unzip the package and save the \*.upg file to the root directory of a USB disk and insert it into ENR USB port.

1. On **Live** screen, click **Setup** → click **Maintenance** tab → select “**Firmware Upgrade**”.
2. Click “**Browse**”, find the target \*.upg file and click “**Open**”.
3. Click “**Upgrade**”.

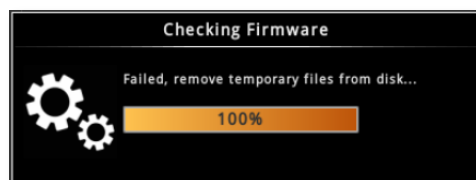
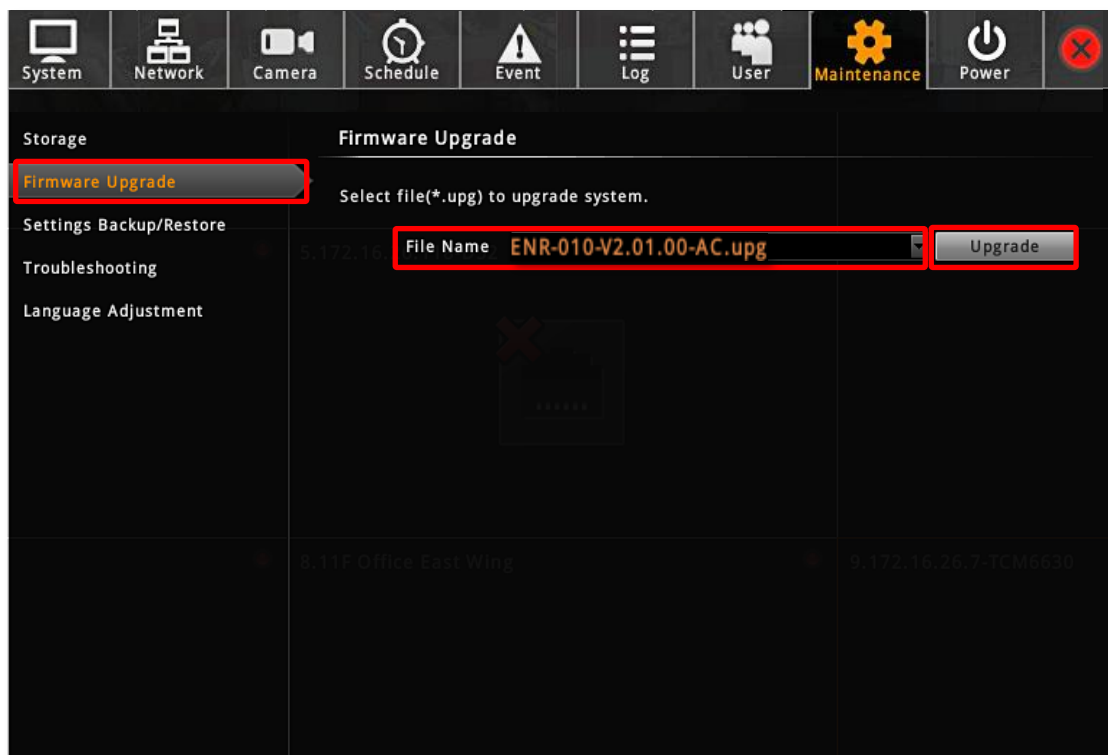

During upgrading, the system will stop every other activity including recording and event handling. The system will auto-restart after the upgrading completes.

After upgrading has started, **DO NOT cut off the system power or eject the USB disk until ENR restarts.**

### Please note that

The USB disk carrying the firmware image should at least have **200 MB** free space.

## Backup / Restore Settings

Making regular system backups is always recommended in case of unexpected disasters or accidents that may damage ENR server.

ENR server can create a backup file of the whole system settings as

**Backup\_[yyyymmdd].nvr** file and save it to a connected USB disk within one click. The backed up settings include the following properties: (1) **System Settings** including **System Name, Date & Time, Network, Email, Mouse and Keyboard**, (2) **Camera Settings**, (3) **Schedule Settings**, and (4) **Event Management**.

The recordings will be kept on hard disks, please refer to *ENR User's Manual* to export a system log file and to export video files for a complete backup.

### Backup

To start backing up system setting, please insert a USB disk into ENR first.

1. On **Live** screen, click **Setup** → click **Maintenance** tab → click **“Settings Backup / Restore”**.

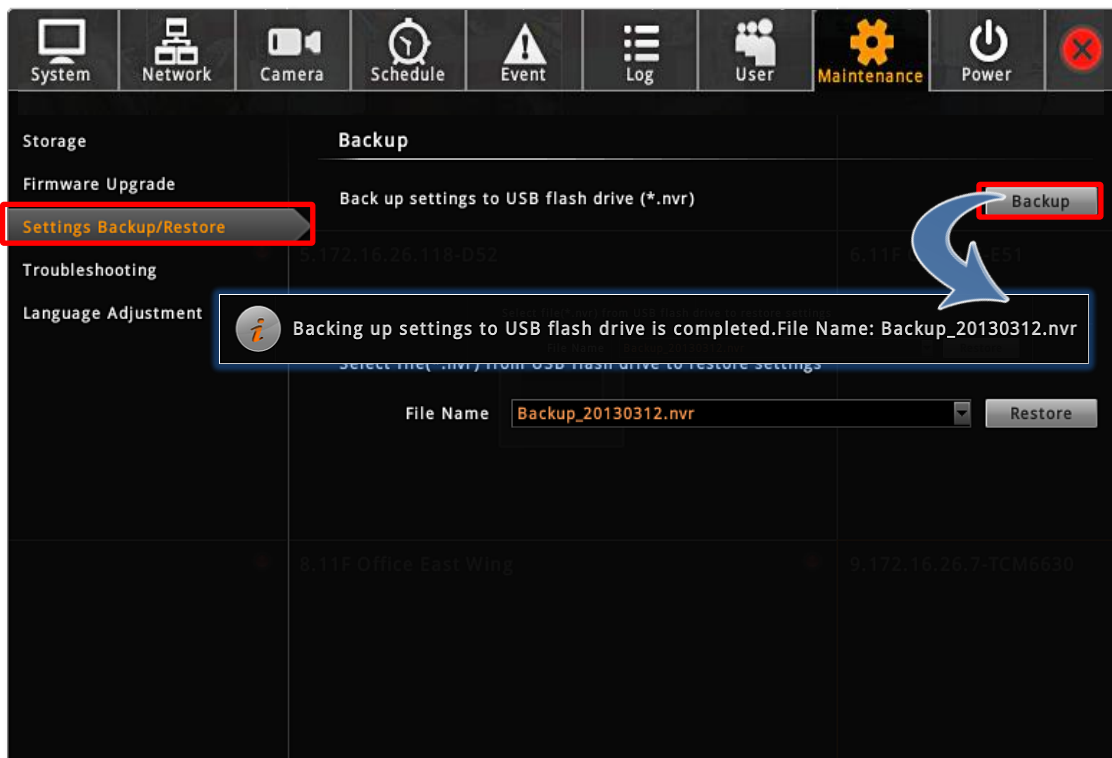

2. Click **“Backup”**, the backup file will be saved to your USB disk as .nvr file.

## Restore

Before starting restoring the system, make sure you have connected the USB disk with the desired .nvr backup file in it, and the backup file is saved in the root directory.

1. On **Live** screen, click **Setup** → click **Maintenance** tab → click “**Setting Backup / Restore**”.

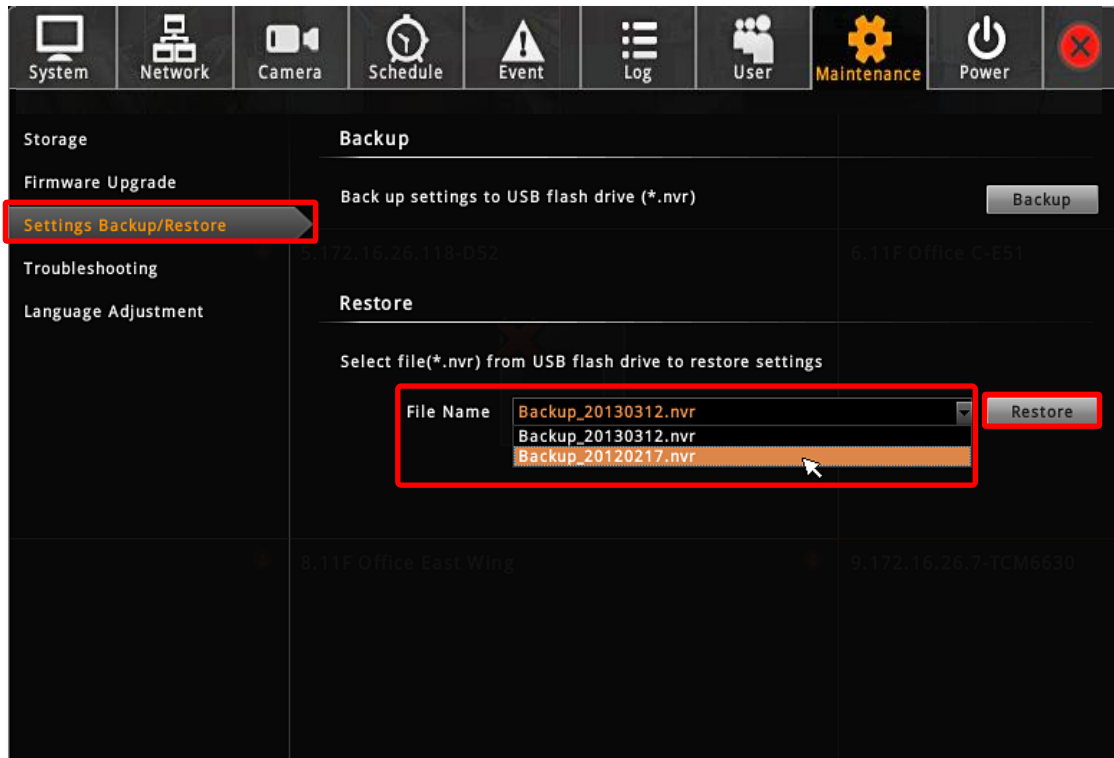

2. All the .nvr file detected from your USB disk root directory will be shown on the **File Name** dropdown list, select your desired one.
3. Click “**Restore**” to start restoring the settings. The server will restore the settings from the backup file and reboot.



## Customize Live Screen Layout

You may customize the layout style, channel position and patrol behavior. Your arrangement of **Live** screen layout will be the default view after any local user logs in to ENR.

### Change Channel Position

You may place any channel in your desired window, and ENR will remember this arrangement until you change it.

You may move a camera view to any position by dragging it to the target channel.

In the example below, the green numbers represent the order of channels. Dragged by the mouse, **Camera 1** will be swapped from **Channel 1** to **Channel 5**.

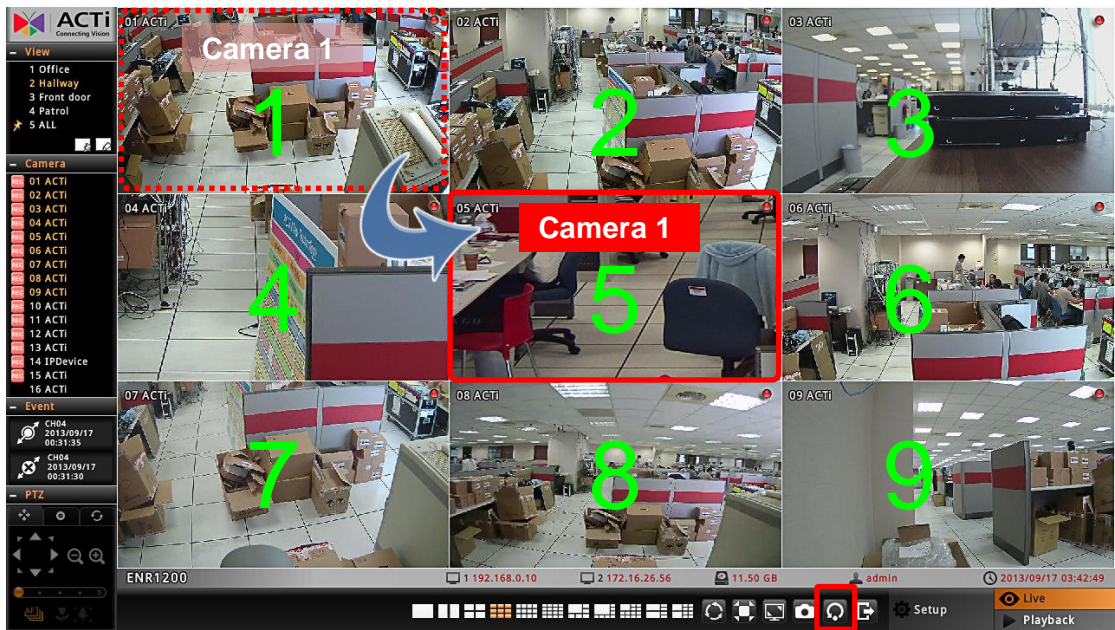

You can **Reset** the camera positions by clicking  on **Live Menu**.

### Change Layout

To select a desired layout, click one on **Live Menu**. Each layout will display specific windows shown below. Therefore, you have to make sure the cameras you desired to watch are placed in the designated channels before applying the layout.





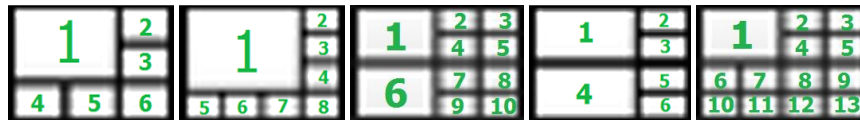

For example, to watch **Camera 2,4,6,8** in a **quad layout**, you should:

1. Select a square grid layout (2x2, 3x3 or 4x4) where you can see all channels.
2. Place **Camera 2** into **Channel 1**, **Camera 4** into **Channel 2**, **Camera 6** into **Channel 3**, and **Camera 8** into **Channel 4**.



3. Select the **2x2** layout on **Live Menu**.





### Note

The five customized views for local live view and those for remote live view are maintained separately; therefore, any modification you make to the views on **View** here list will not affect the View settings on remote **Live** screen.

## Execute Sequence Patrol

The patrol function will slide-show multiple channels at your defined length of interval. At one time the layout will show as many channels as its maximum display channels. For instance, as Patrol is enable, a 3x3 layout will show channel 1~9, then 10~16 by turns.



1. On **Live Menu**, click  to bring up the **Patrol Time Setting** window.
2. Input the patrol time
3. Click “OK”, the patrol will start until you click  again.

## Save a Customized View

You may save up to five customized view on local **View List**. A saved view will remember (1) the layout style, (2) camera arrangement, (3) view size (stretched / un-stretched / full-screen) and (4) Patrol setting.

1. Select a View from the **View List**.
2. Customize your layout with the tools provided on **Live Menu**.
3. Click  in bottom right corner of **View List**, enter

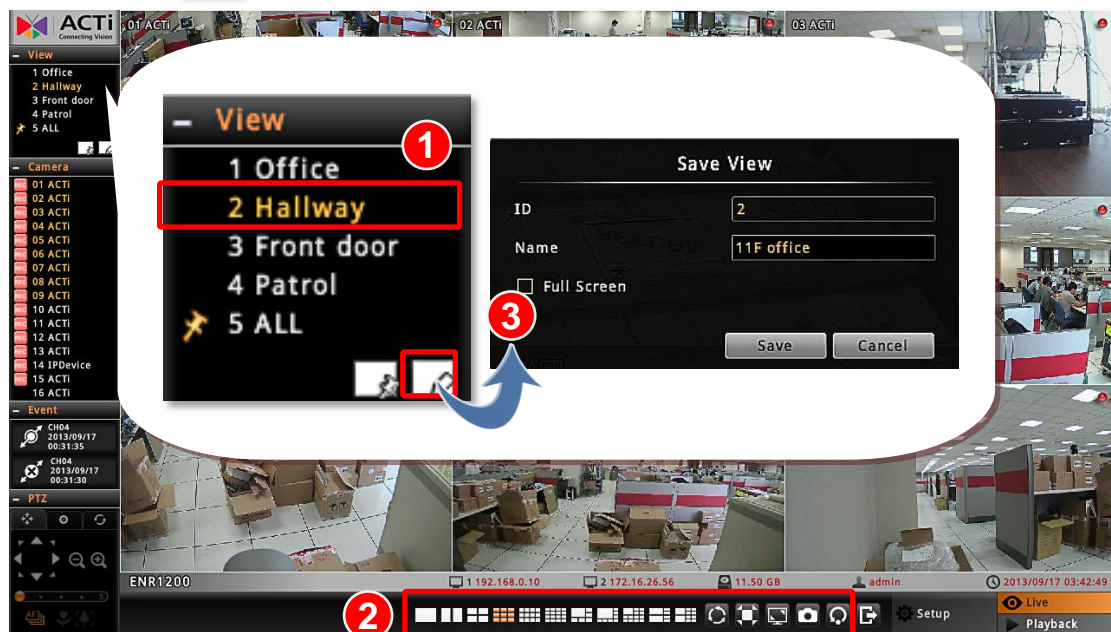

## Set a Default View

If you have enabled “**Auto-login**” function (please refer to [Set Auto Login](#) on page 31), you may also set one View as default, in this way, you may immediately start live monitoring after the system starts up. To set a default view, simply select a desired view on **View** list, and click



## Customize System Language

ENR user interface supports multiple languages and offers you the flexibility to change the wording. There are over **10** supported UI languages you may choose on **Login** page. Each language (**except for English**) is open for customization based on your own needs. This section will describe how to choose or customize language wording for your ENR.

To start, you need to connect a USB disk to ENR to export the language file for editing.

### Modify the Wording

After the USB disk is connected,

1. On **Live** screen, click **Setup** → click **Maintenance** tab → click “**Language Adjustment**”.
2. On **Language Adjustment** page, below **Export Language** section, select your desired language form original language file list, and click “**Export**”. ENR will pop up a window as the file is successfully saved to USB disk.

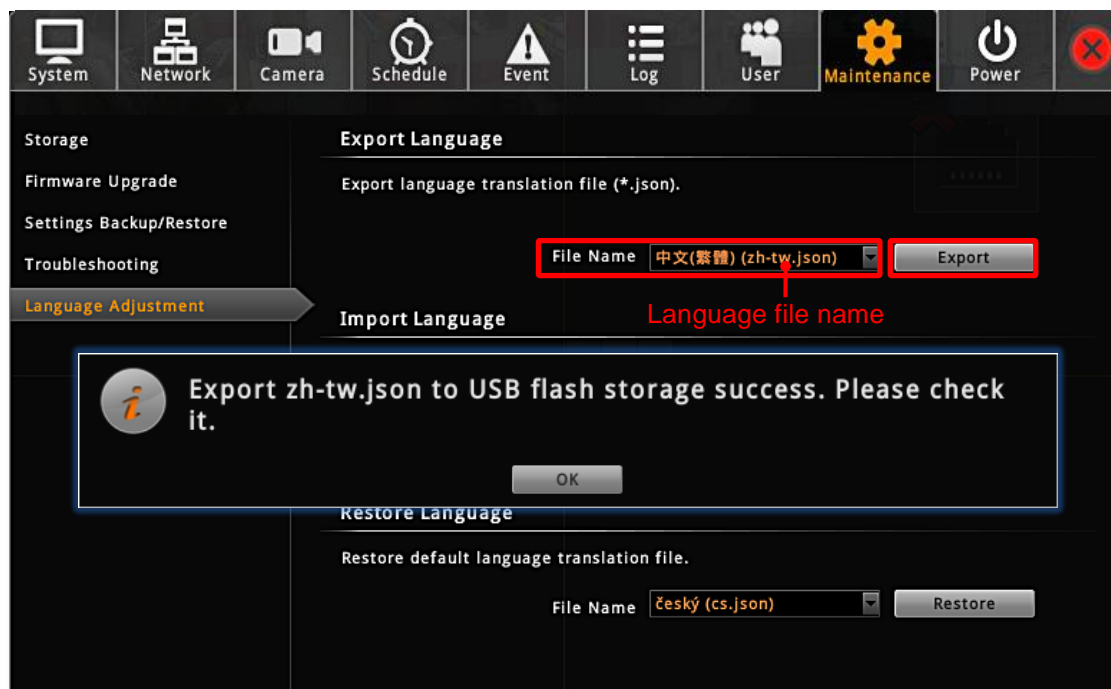

3. On a computer, open the file ( \*.json) with a text editor program. Each entry represents the current wording of an object. Please edit the wording of your language embedded in quotation marks (“ ”) on the right of the colon; The English term appearing on the left is the original system code, which should be left unchanged.

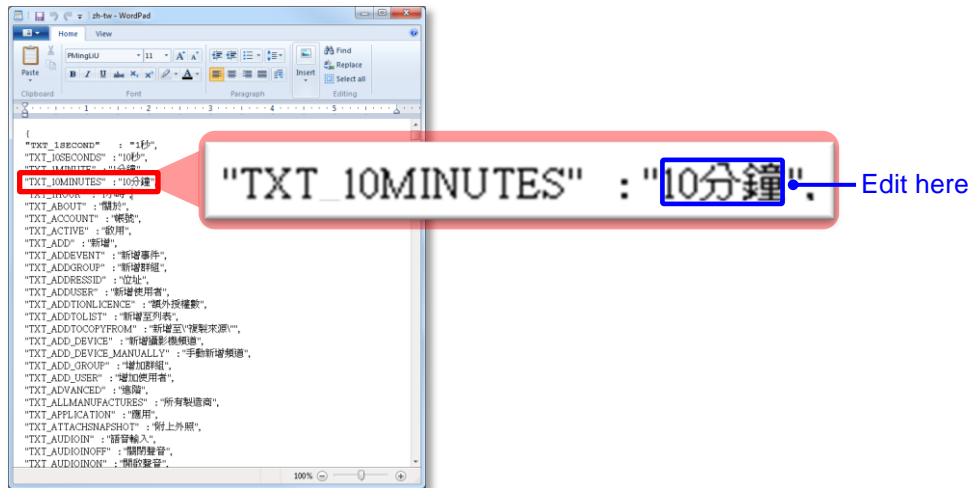

- After the modification is done, save this file with its original file name and file type onto the USB disk, make sure the text encoding format is **UTF-8**.
- Connect the USB disk with ENR, on **Language Adjustment** page, select the language file from drop-down list below **Import Language** section, and click "Import". ENR will pop up a window as the file is successfully imported into ENR server.

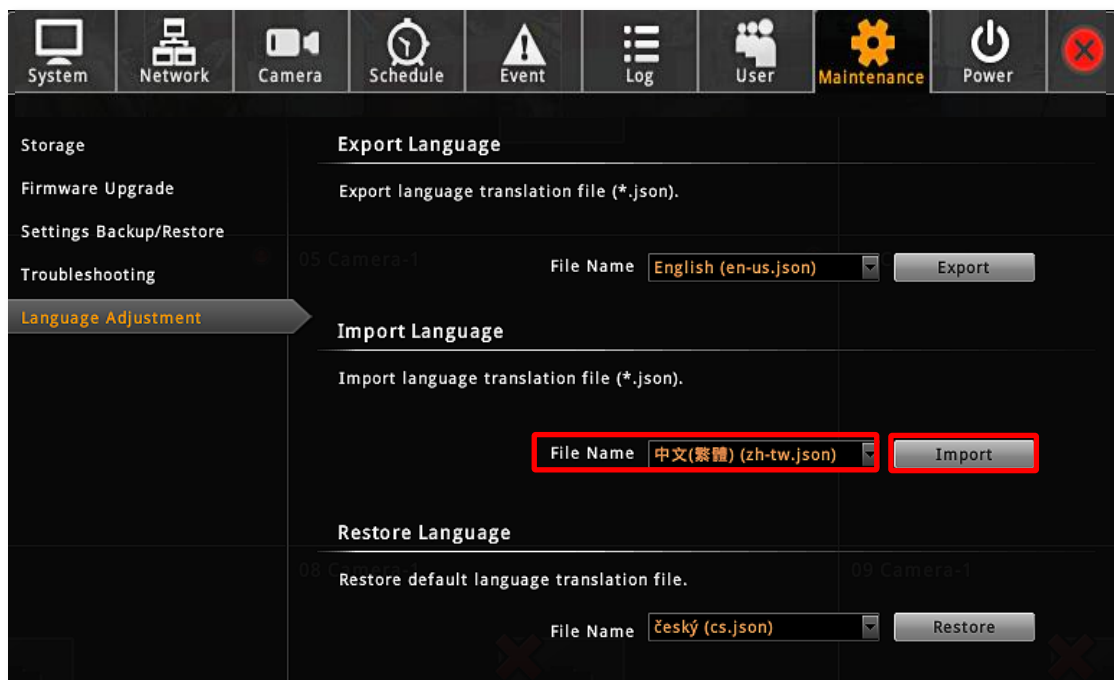

- Log in to ENR again. On **Login** window, select the UI language before you click "Login".
- Check the UI to see if the modified term is correctly shown.

### Restore the Wording

ENR always keeps the original language file in its memory, so you can restore the language wording to default. On **Language Adjustment** page, select the language file from drop-down list below **Restore Language** section, and click "Restore". The entire original language wording will restore after you log into the system again.



# Remote Client Operation

## Access ENR Server

A remote client refers to any client using a computer over WAN or LAN other than server computer. If you know the IP address and port number of the ENR, you may type in the IP address and port number directly into Internet Explorer. Sample IP will look like this:

<http://220.228.146.21:1000> or domain name <http://enr.acti.com>. If the port number is **80**, you do not need to append it when typing the address.

[http://ip address:port number](#)

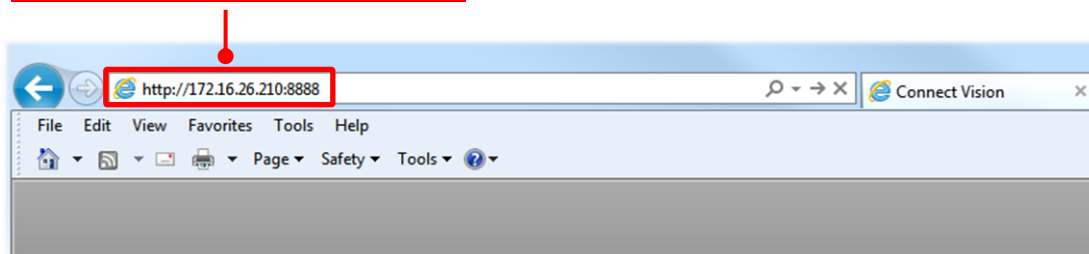

## Find ENR in Your Network

The ip address of both ENR's LAN ports are shown on local live screen.



If your client computer and ENR are both within the same network, find ENR's IP address via the following two quick methods - **UPnP** connection or **ACTi IP Utility**.

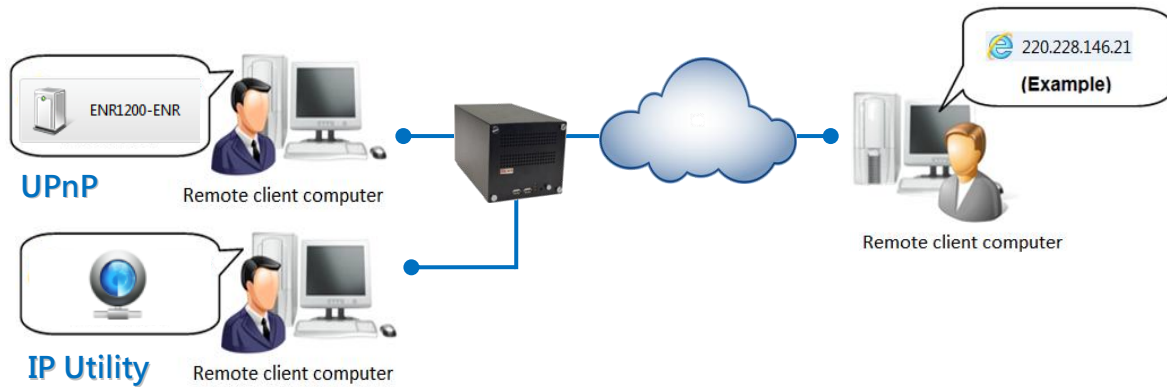

### Via UPnP Connection

ENR supports UPnP connection. This means that once the device has an IP address, you will be able to find it in the local network in **Windows Explorer** → **Network**. Please note that your PC must be in the same subnet with ENR.

Once you locate ENR, double-click on it to open the client browser.

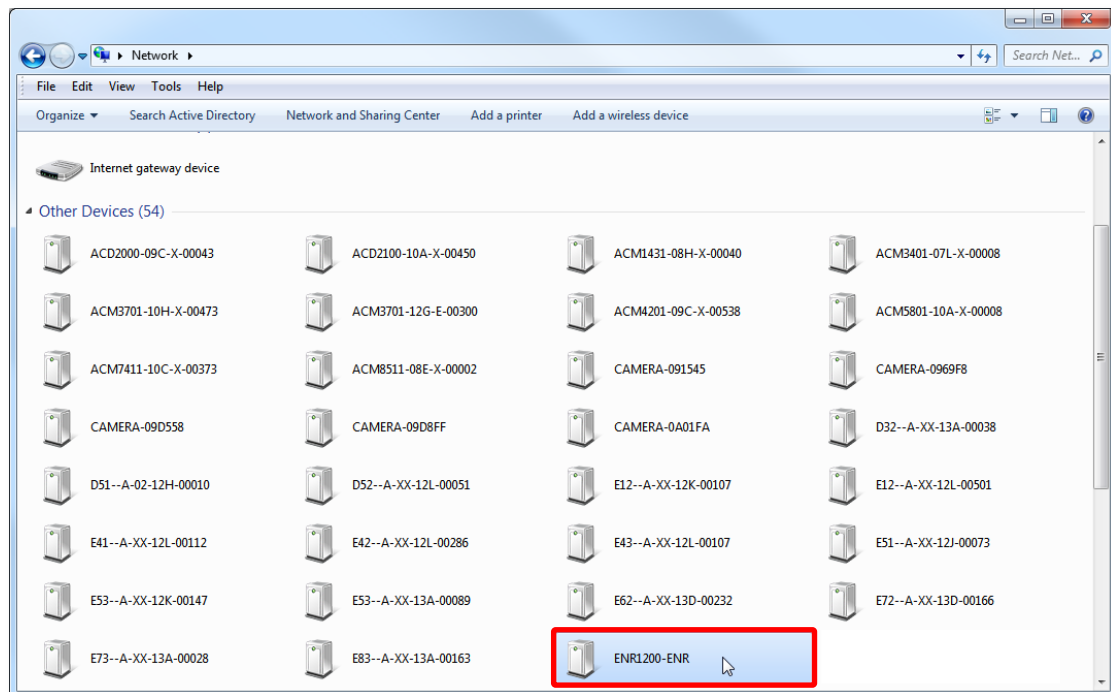

## Via ACTi IP Utility

ACTi IP Utility is a software tool used to find all ACTi products including cameras and ENR servers. Download the latest IP Utility from the link below and install it on your computer.

<http://www.acti.com/downloadcenter>

Execute this program, and find ENR from the search list, double-click on the **IP address** to open the client browser.

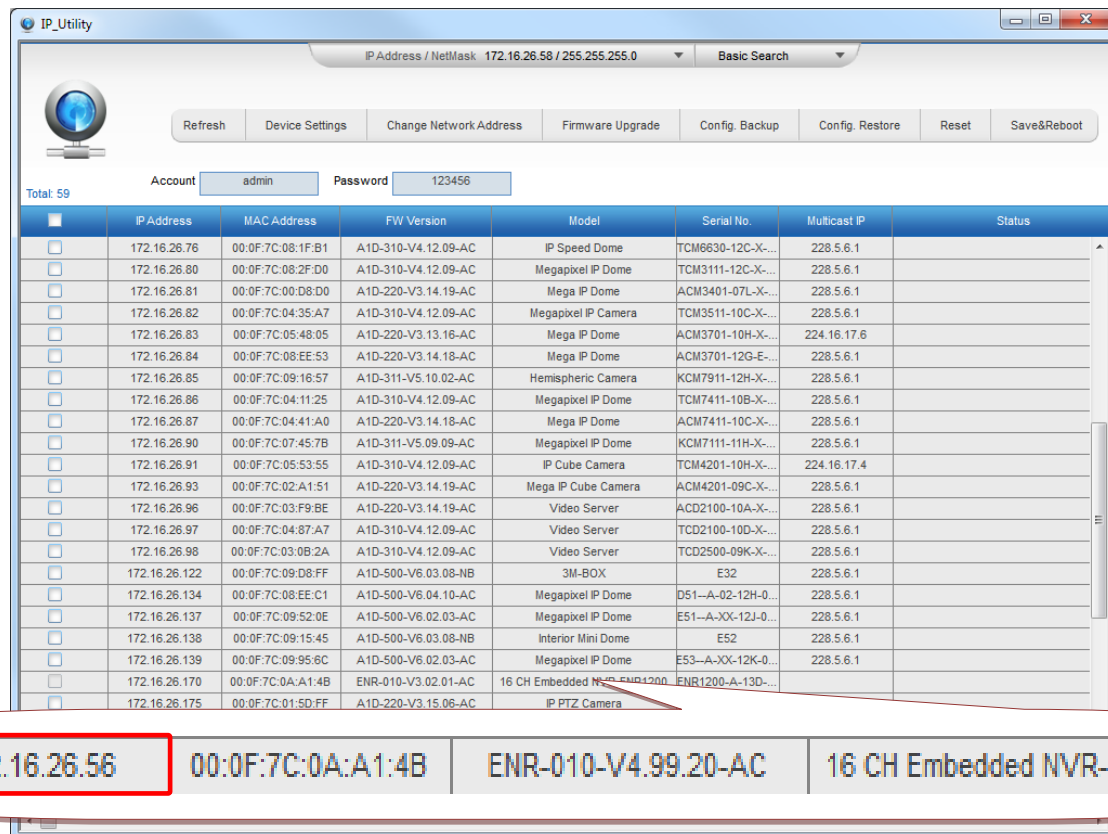

The screenshot shows the ACTi IP Utility interface. At the top, it displays the IP address and netmask: 172.16.26.58 / 255.255.255.0. Below this is a search bar and a row of buttons: Refresh, Device Settings, Change Network Address, Firmware Upgrade, Config. Backup, Config. Restore, Reset, and Save&Reboot. The main area shows a table of devices with columns for IP Address, MAC Address, FW Version, Model, Serial No., Multicast IP, and Status. A red box highlights the IP address 172.16.26.56 in the table. A callout box below the table displays the following information:

172.16.26.56	00:0F:7C:0A:A1:4B	ENR-010-V4.99.20-AC	16 CH Embedded NVR-ENR1200
--------------	-------------------	---------------------	----------------------------

## Log In / Out

After you By default, an administrator account has already been existing in your system. To log in to ENR for the first time, you will have to key in the password in **Login** window.

### Log In

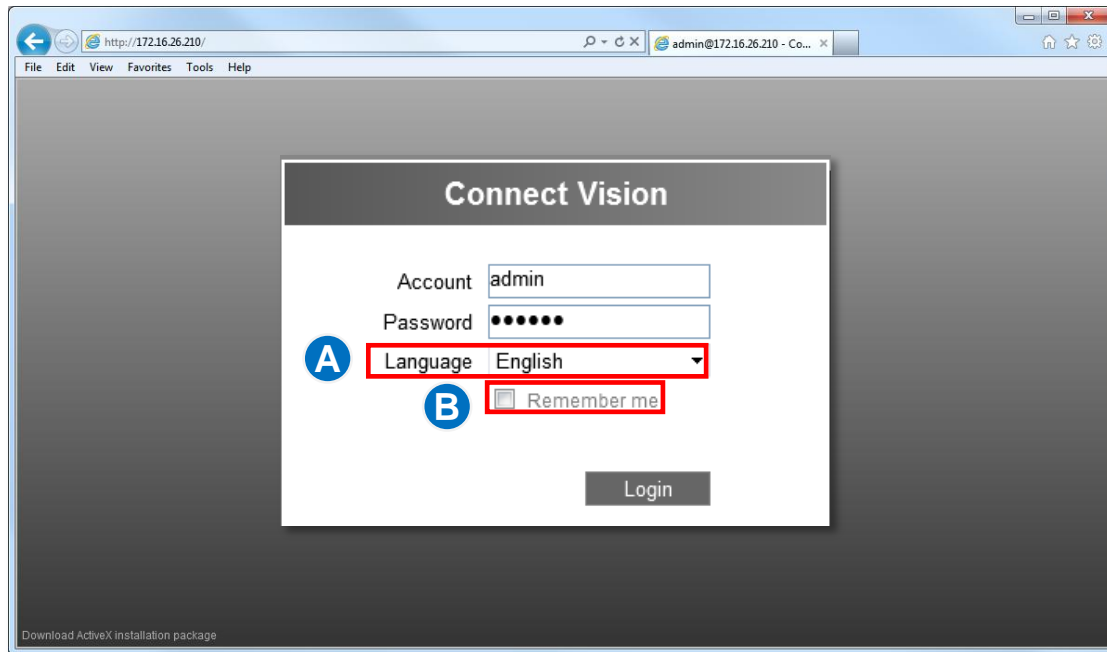

#### Enter Account & Password

- **Account** (non case-sensitive): **Admin** (default)
- **Password** (case-sensitive): **123456** (default)

#### Change UI language **A**

To change UI language, select the desired language from “**Language**” dropdown list.

#### Remember Login Information **B**

To have the server remember your **Account**, **Password** and language setting for future, check “**Remember me**”.

### Log Out

On **Live** screen, click “**Application**” → “**Logout**”.

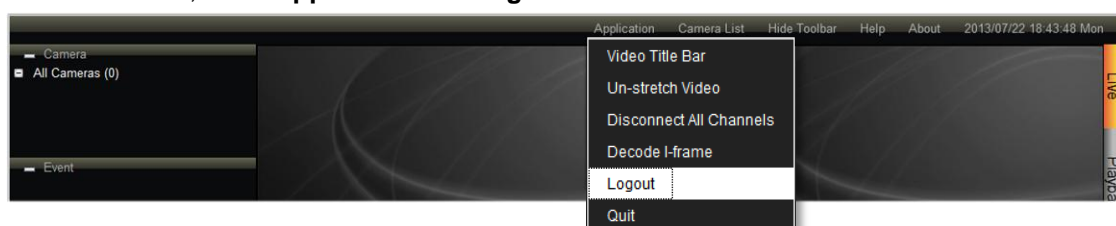



## Accept ActiveX Controls Installation

ENR interface requires the add-on ActiveX Control components, please allow ActiveX controls to be downloaded and installed.

It is strongly recommended that (1) you add this ENR server into Internet Explorer's Trusted Sites and (2) turn off Windows Firewall on this client computer.

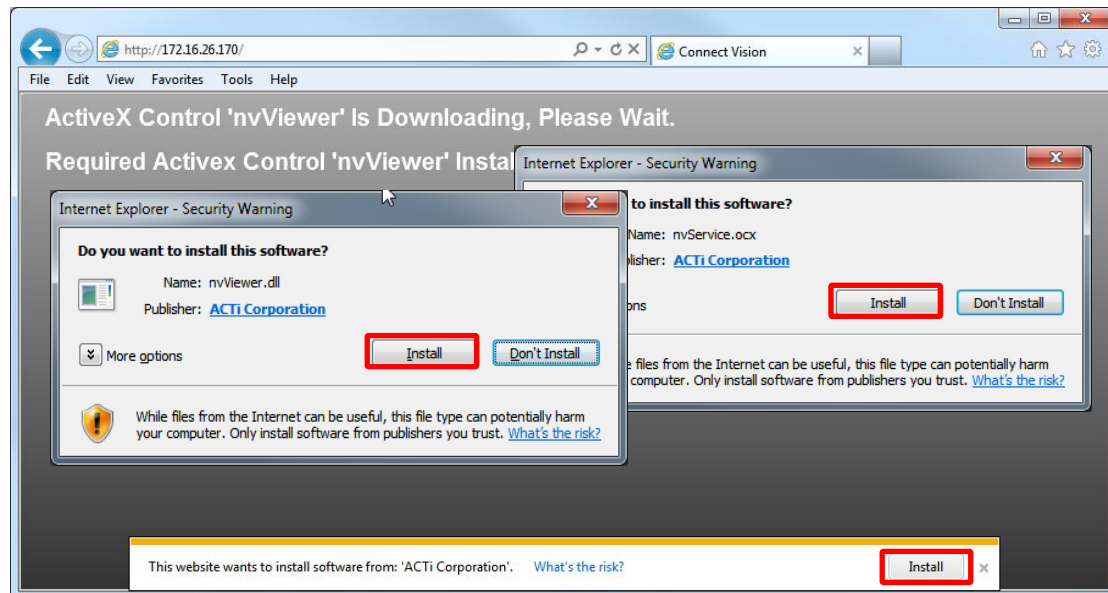

## Setup Wizard

After logging in, if no camera has been added to ENR system, **ENR Setup Wizard** will lead you through three essential installation steps in order that you could quickly get camera live view.

For video recording, please remember to install hard disks and format them in physical ENR device.

You may click the **Done** bubble to skip to the quick setup procedures last step.

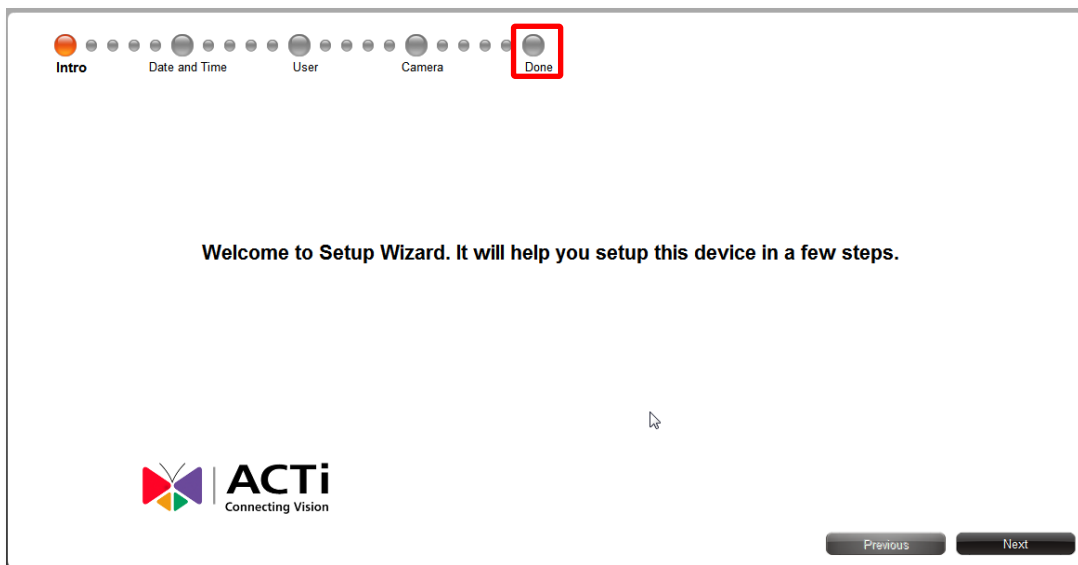

And click **Done** to exit **Setup Wizard**.

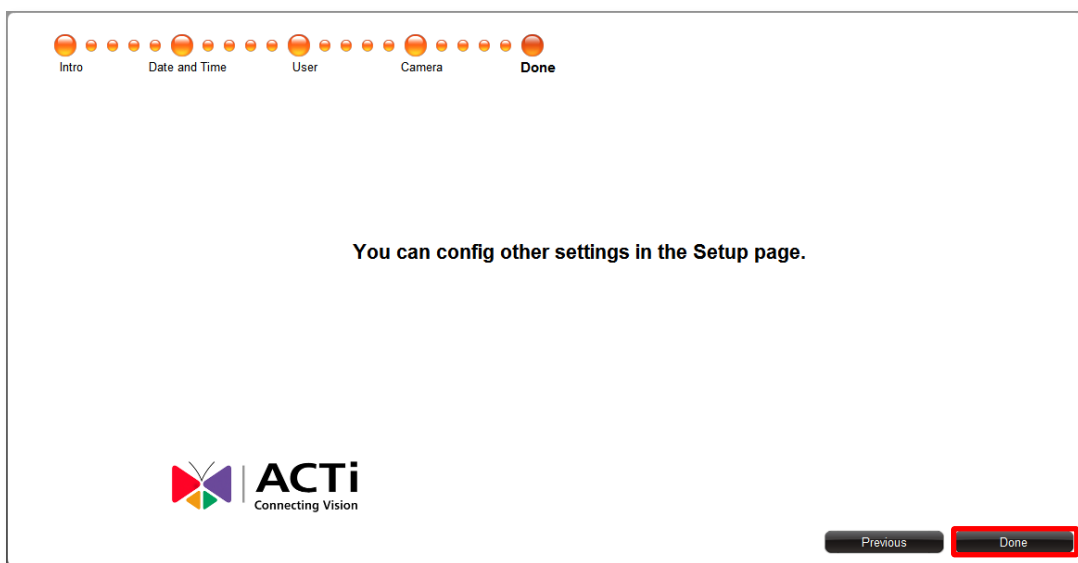

## Setup the System

Before adding cameras to the system or starting up the recording and event handling, it is essential to configure certain system-wise settings on **Setup** page.

### Set System Name

Go to **Setup** page → **System** tab → **Information**

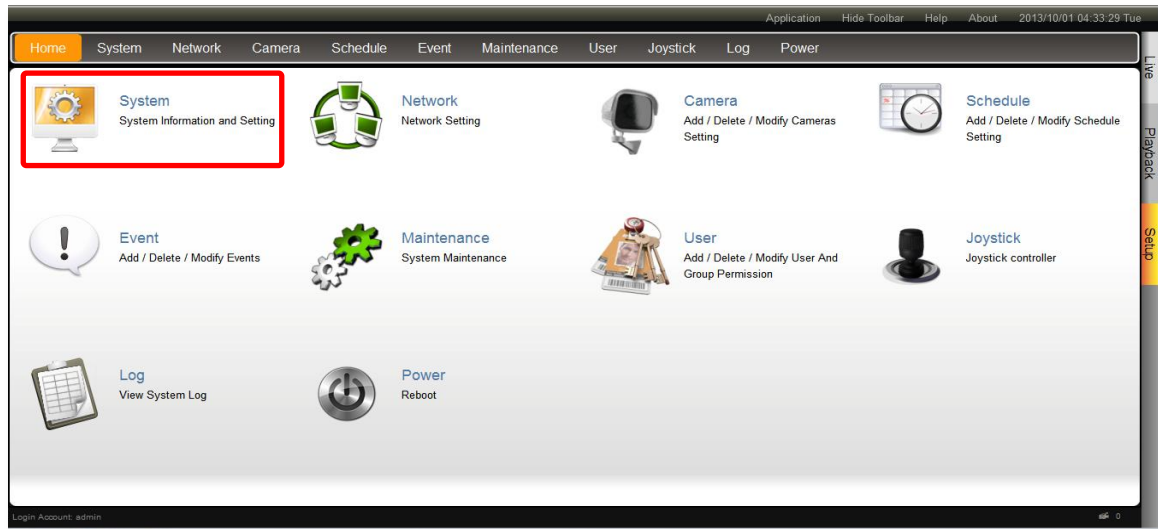

Modify the name of this ENR server and click **“Save”**. The maximum length is 10 digits of English alphabets.

Your ENR's current firmware version, serial number and MAC address are also shown here.

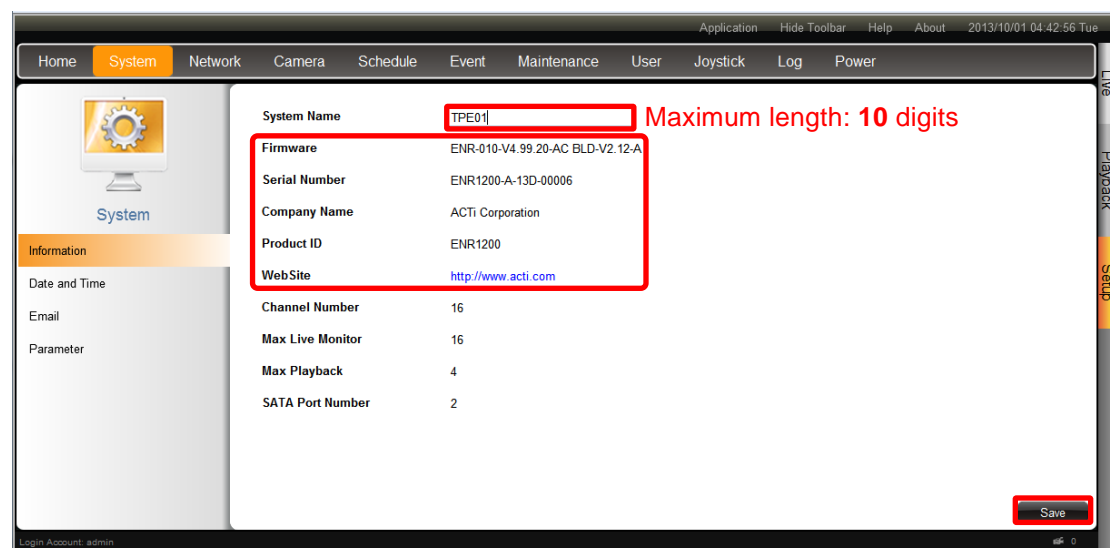

## Set Date & Time

Go to **Setup** page → **System** tab → **Date and Time**

You may configure other time-related settings here.

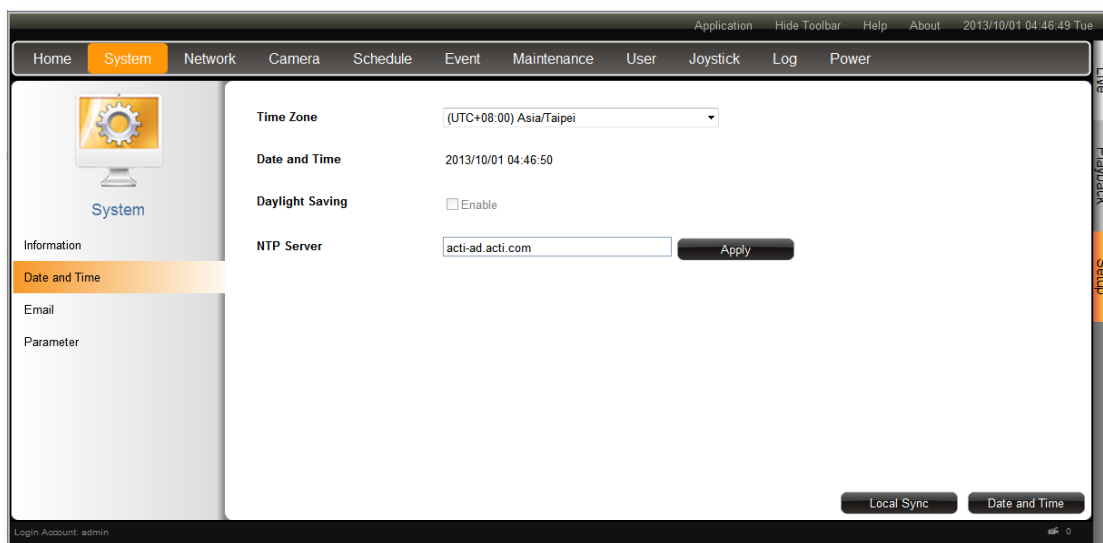

### Change Time Zone

Select the time zone where ENR server belongs to. After selecting the time zone, it will change to the corresponding date and time.

### Change Date and Time

It shows the current date and time on the device. Click **Date and Time** to bring up the calendar. Input the exact date and time, then click **OK**.

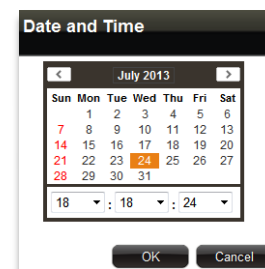

### Set Daylight Saving

If the device is located in an area where daylight saving time is used, click the check box to enable daylight saving. The time will be automatically adjusted. When the daylight saving time has finished, uncheck the box to return to original setting.

### Set NTP Server

Please enter a NTP server address and click **Apply** to synchronize time with the NTP server. Make sure ENR has connection with the NTP Server.

To delete this NTP server, simply clear its address in this field and click **Apply**.

#### Note

If your NTP server is a domain name address, make sure you have configured the **DNS Setting** and chosen appropriate Default **Gateway** on **Setup** page → **System** tab → **Network**

### Synchronize with Client Computer's Time

Click **Local Sync** to synchronize the device time with the time on the computer you are using now, please click this button.

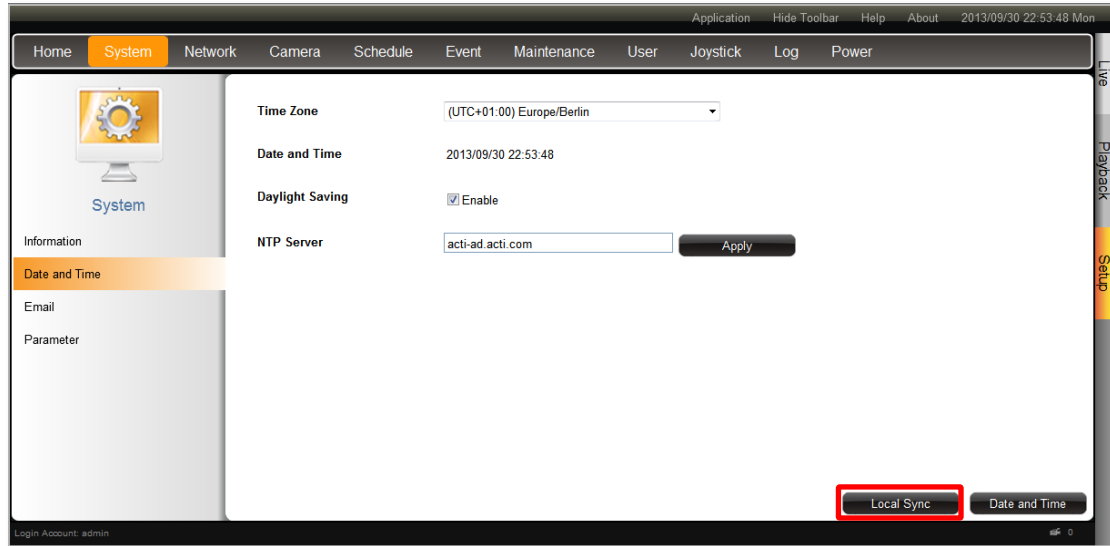

## Configure Network Settings

There are two network interface cards in ENR.

Either of these cards can be supported by the built-in DHCP server feature, which enables ENR to assign IP addresses to cameras via **LAN1** or **LAN2** port without another DHCP on router.

By default, **LAN1** card uses a fixed IP address **192.168.0.10**, while **LAN2** is in **DHCP** client mode. It is suggested that you connect **LAN1** to LAN and connect **LAN2** to WAN.

## Current IP Configurations

Go to **Setup** page → **Network** tab.

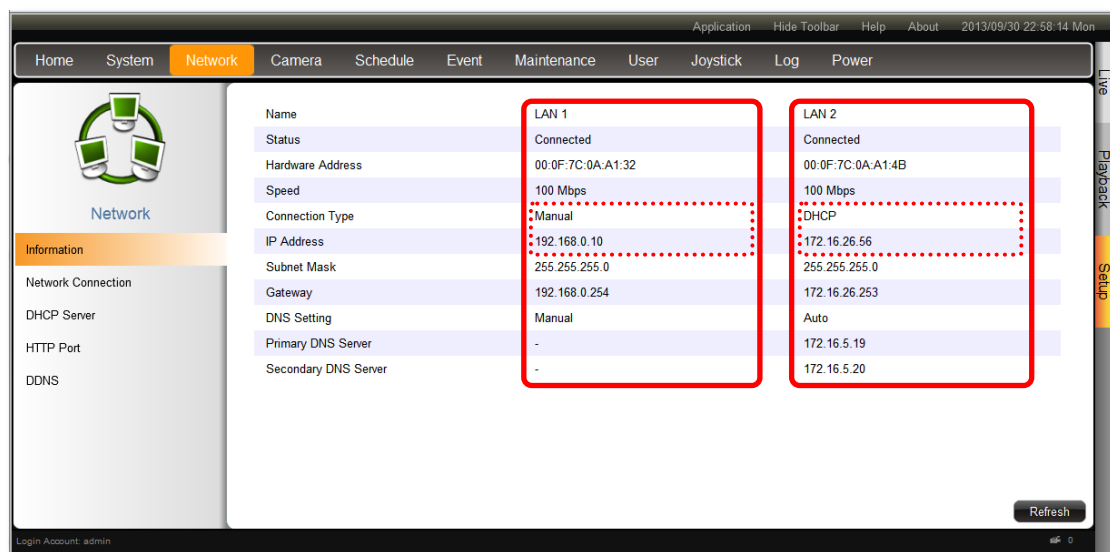

Parameter	LAN 1	LAN 2
Name	LAN 1	LAN 2
Status	Connected	Connected
Hardware Address	00:0F:7C:0A:A1:32	00:0F:7C:0A:A1:4B
Speed	100 Mbps	100 Mbps
Connection Type	Manual	DHCP
IP Address	192.168.0.10	172.16.26.56
Subnet Mask	255.255.255.0	255.255.255.0
Gateway	192.168.0.254	172.16.26.253
DNS Setting	Manual	Auto
Primary DNS Server	-	172.16.5.19
Secondary DNS Server	-	172.16.5.20

## IP Settings

On **Network** tab, click **Network Connection** then select the interface card that you wish to set up. After setting up, please click **Save** on the bottom right side to save the settings.

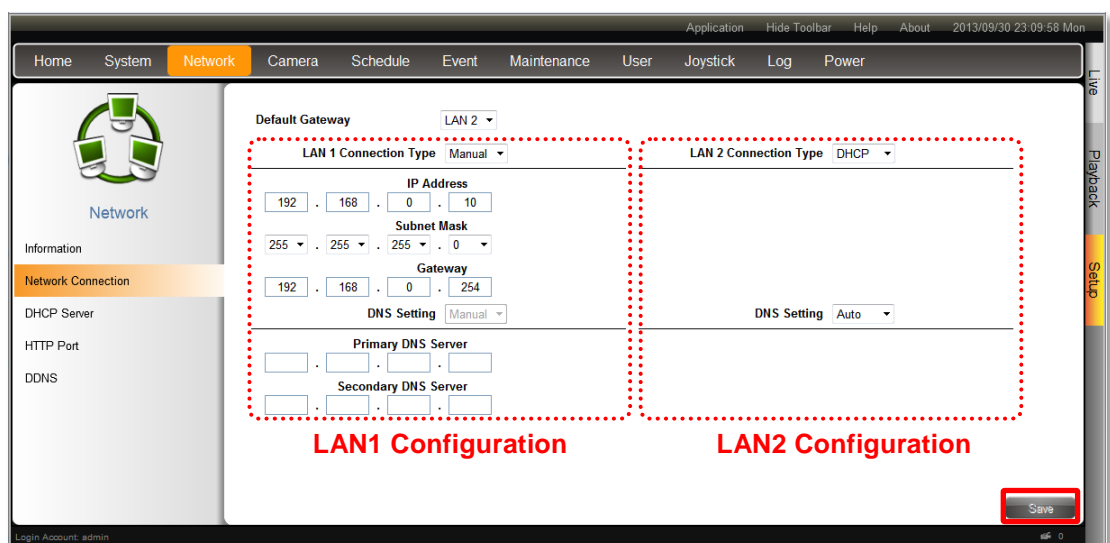

Default Gateway: LAN 2

LAN 1 Configuration	LAN 2 Configuration
LAN 1 Connection Type: Manual IP Address: 192 . 168 . 0 . 10 Subnet Mask: 255 . 255 . 255 . 0 Gateway: 192 . 168 . 0 . 254 DNS Setting: Manual Primary DNS Server: [ ] . [ ] . [ ] . [ ] Secondary DNS Server: [ ] . [ ] . [ ] . [ ]	LAN 2 Connection Type: DHCP DNS Setting: Auto

Save

Please note that any change you make on this page requires the system to restart its service, please wait for a while and reconnect ENR using the new properties.

Field Name	Description
<b>HTTP Port</b>	The connection port is used for remote web client to communicate with ENR. Default is <i>80</i> .
<b>Default Gateway</b>	Default uses <i>LAN2's setting</i> .
<b>Connection Type</b>	<p>Choose one connection type for this LAN port. DHCP and PPPoE service will assign an IP Address to ENR, and there is no need for you to define other network information.</p> <p><b>Manual:</b> Please obtain a static IP address and other network information including Subnet Mask, Gateway and DNS server from your network administrator.</p> <p><b>DHCP:</b> Use this connection type if you have a DHCP server on your network router.</p> <p><b>PPPoE:</b> Chose this when your ISP is using PPPoE type DSL line. Please contact you ISP to get the <b>Username</b> and <b>Password</b> for this connection. <b>LAN1</b> default is <i>Manual</i>; <b>LAN2</b> default is <i>DHCP</i>.</p>
<b>IP Address</b>	Fixed IP Address. <b>LAN1</b> default is <i>192.168.0.10</i> ; <b>LAN2</b> default is <i>Auto</i> .
<b>Subnet Mask</b>	Used to define if the destination is in the same subnet. <b>LAN1</b> default is <i>255.255.255.0</i> ; <b>LAN2</b> default is <i>Auto</i> .
<b>Gateway</b>	A valid gateway setting is essential for data transmission between different subnets, such as accessing the DNS service or SMTP server on the Internet. <b>LAN1</b> default is <i>192.168.0.254</i> ; <b>LAN2</b> default is <i>Auto</i> .
<b>DNS Setting</b>	The DNS server that translates domain names to actual IP addresses. If this LAN is <b>Manual</b> mode, and you will set an SMTP server for event notification, be sure to set the Primary DNS and Secondary DNS. <b>LAN1</b> default is <i>Manual</i> ; <b>LAN2</b> default is <i>Auto</i> .

### Enable DHCP Server

You may enable the built-in DHCP server for either **LAN1** (default) or **LAN2** port.

Go to **Setup** page → **Network** tab → click "**DHCP Server**".

1. Check "**Enable**" and select a LAN, this LAN has to be in **Manual** mode.
2. Set the **Beginning IP Address** and **Ending Address**, and click "**Save**". ENR will assign IP addresses within this range to the cameras connected to the selected LAN port.  
Please (1) make sure the cameras are in DHCP client mode, (2) connect and power the cameras up after you enable this service.

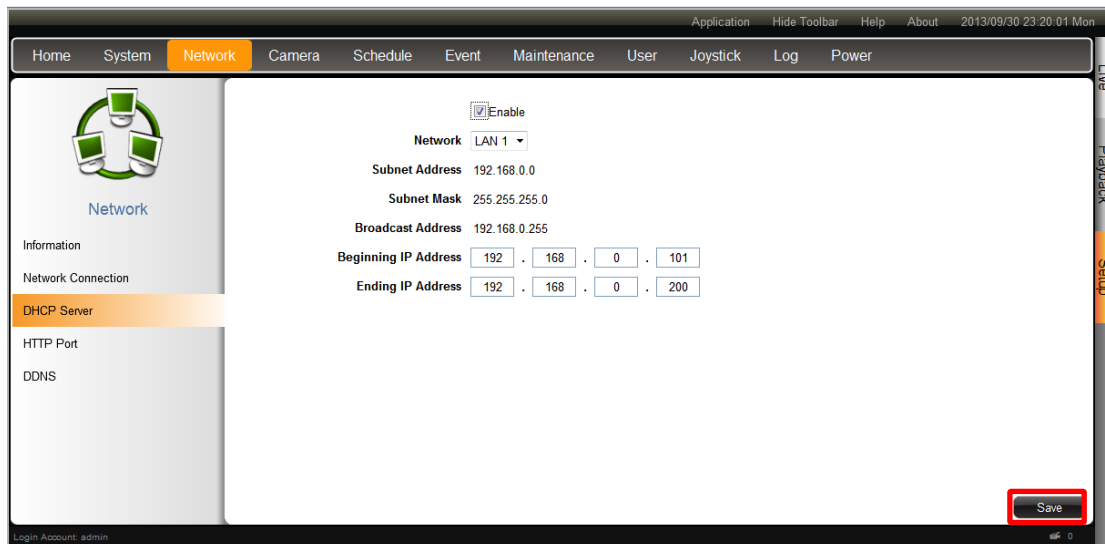

## Set HTTP Port

To change the HTTP port of ENR server, go to **Setup** page → **Network** tab → click “**HTTP Port**”. Configure the port number and click “**Save**”.

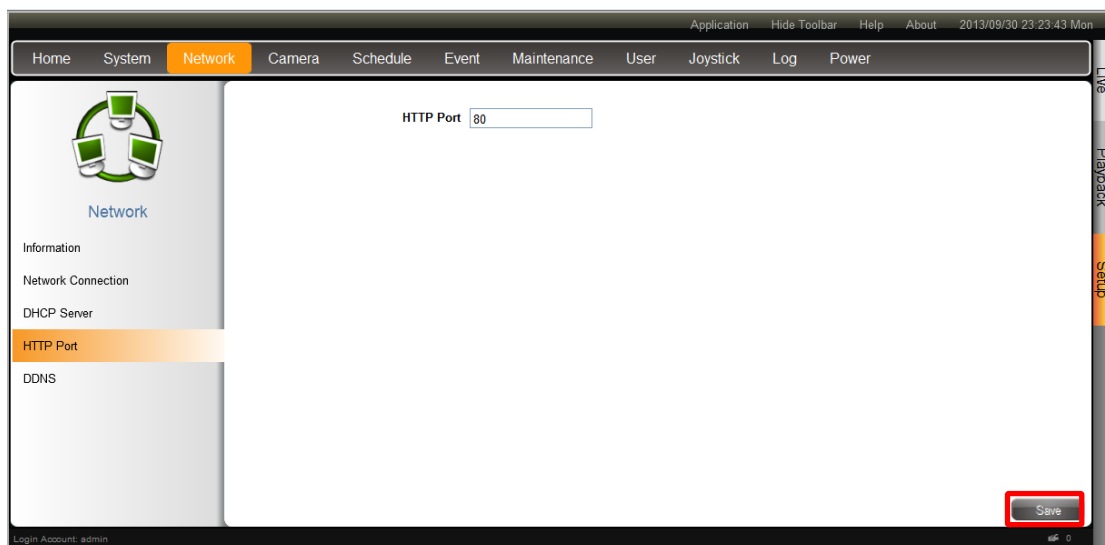

## Enable DDNS Service

ENR has built-in the DDNS update client feature, which saves ENR domain name address information and actively update its ip address to the DDNS provider's server.

1. Visit the dynamic DNS service provider's website and register the domain name for your ENR.

ENR supports the following service providers:

- DynDNS: <http://www.dyndns.com>
- NO-IP: <http://www.noip.com/>

2. Go to **Setup** page → **Network** tab → click “**DDNS**”.



3. Check **"Enable"**, select the service provider, and input the **Host Name**, **User Name** and **Password**.
4. Click **"Save"** to save the settings.

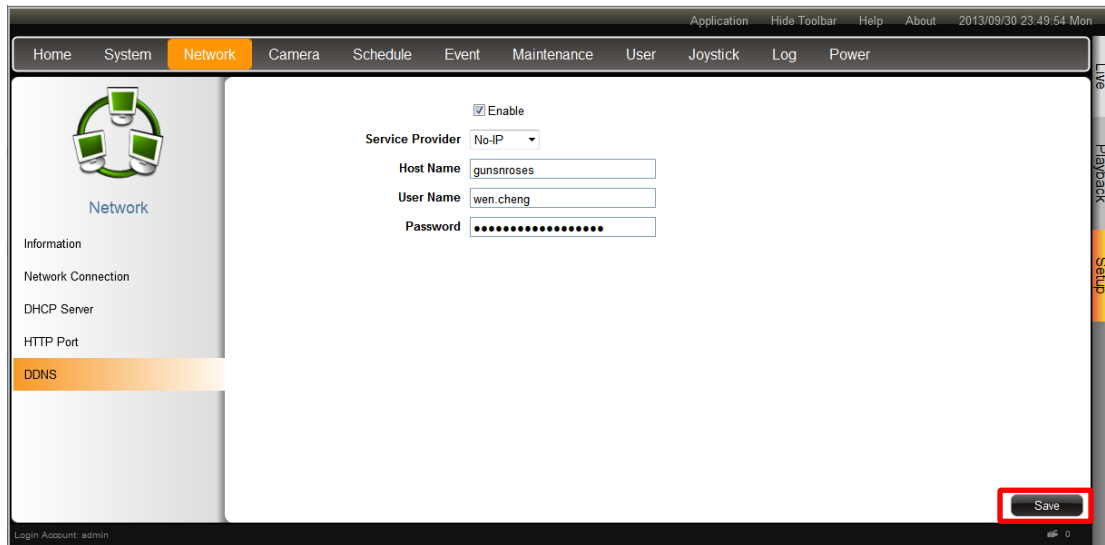

## Set E-mail Notification Service

ENR supports e-mail notification for Event Handling. The e-mails are sent through an SMTP server, the settings of which are configured in this section.

Go to **Setup** page → **System** tab → **Email**.

Please fill up all the fields including **Account** and **Password** to access the e-mail address you input in “**Sender Email**”. ENR will send notification e-mail via this SMTP server when an event occurs. For detailed instruction on how to set up an event rule related to SMTP service, please refer to [Set Event Rules](#) on page 123.

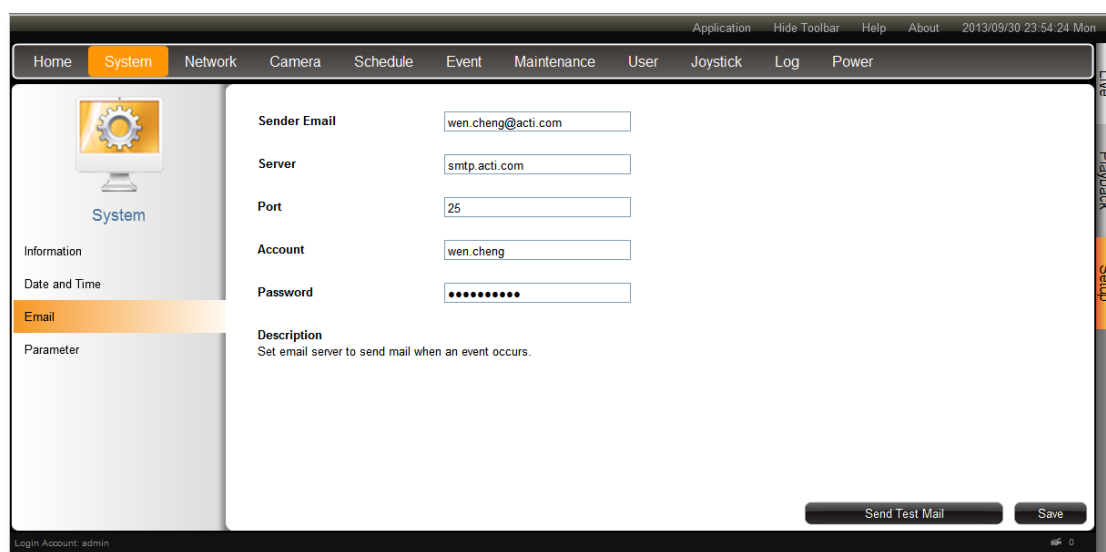

Field Name	Description
<b>Sender Email</b>	Input the sender's e-mail address, should the same account you set for SMTP server.
<b>Server</b>	Input the sender's SMTP server address. Only alphabets, numbers, and the symbols (.), ( _ ), (-) are valid. ENR server <u>supports the SMTP services with SSL protocol</u> . If you wish to use a free webmail SMTP service, you may choose certain webmail providers such as <b>Yahoo</b> (SMTP: smtp.mail.yahoo.com Port:25) or <b>Gmail</b> (SMTP: smtp.gmail.com Port:25 or 465 for SSL protocol / 587 for TLS protocol)
<b>Port</b>	Set the SMTP port, allowed value is from 1~65535, default is <b>25</b> .
<b>Account</b>	Input the name of the SMTP server account. The form of account name depends on mail server, e.g. a Hotmail account name is a complete e-mail address, while other e-mail servers' may be not. Only alphabets, numbers, and the symbols (@), (.), ( _ ), (-) are valid.
<b>Password</b>	Input the password of the SMTP server account. Only alphabets and numbers are valid.

After configuring, please click **"Save"** to save settings, and click **"Send Test Mail"** to validate this configuration, if this configuration is correct, a test e-mail will be sent to **Sender Email**, please login your SMTP server to check incoming e-mails.

## Live Screen Event List Setting

The max number of latest events that can be displayed in event panel. Default is 100.

You can configure this setting on **Setup** page → **System** tab → **Parameter**.

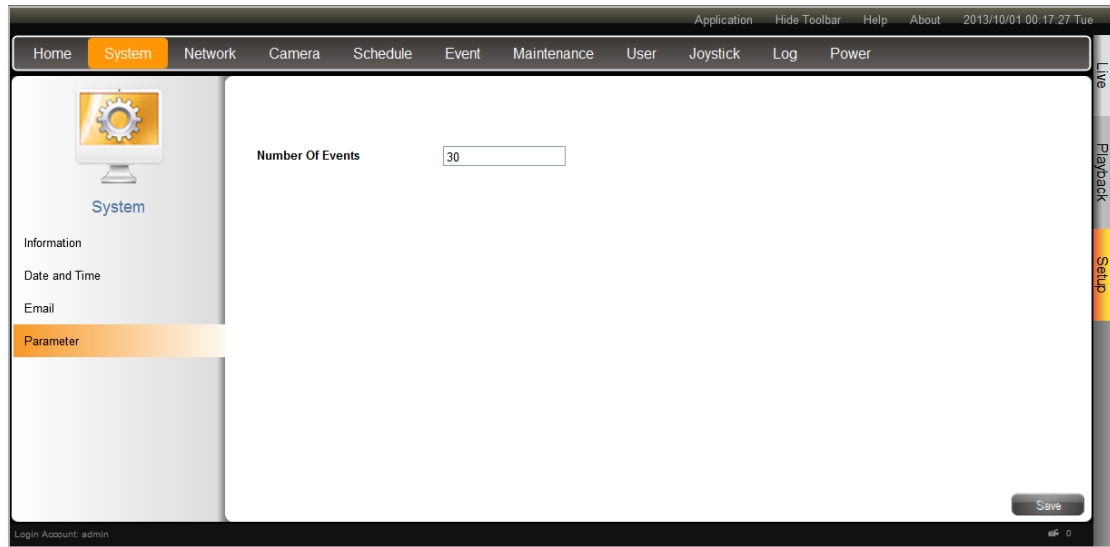

## Live Page UI Overview

After logging in, you will enter **Live** screen. **Live** screen is the interface where you see the live views from your cameras. It is where most of the security professionals access the surveillance system

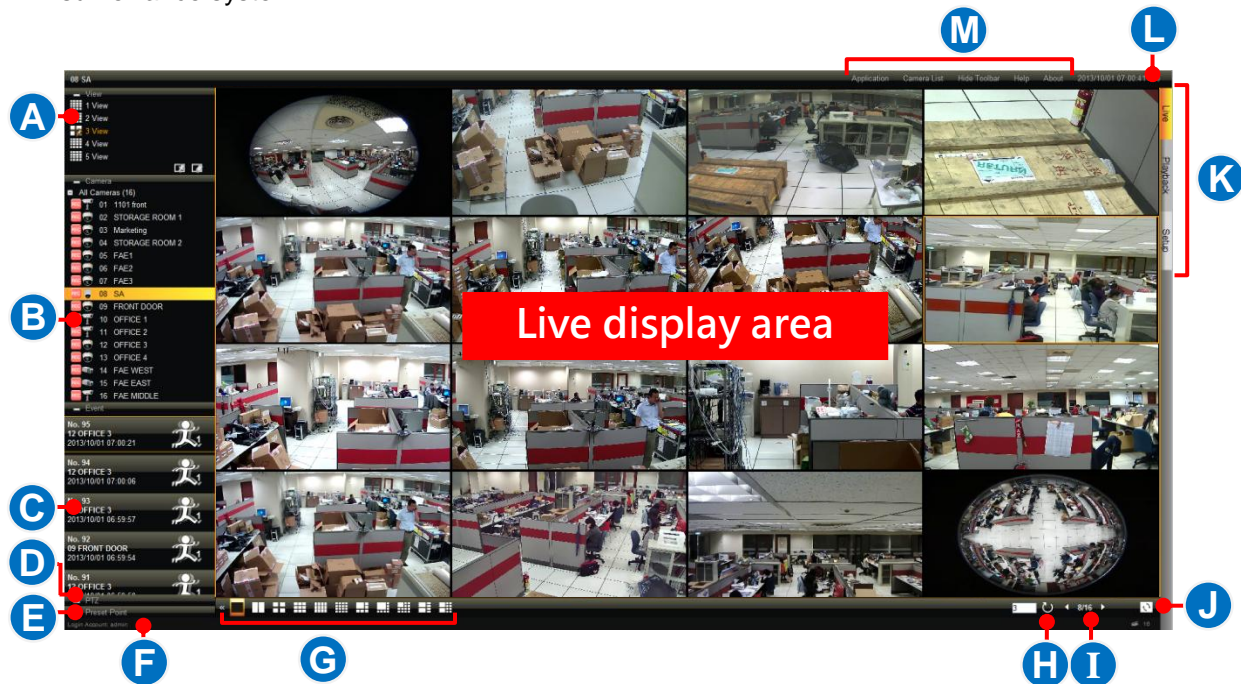

No	Description
A	<b>View List:</b> Lists <b>five</b> View profiles for customization
B	<b>Camera List:</b> Lists all the added cameras and their recording status.
C	<b>Event List</b> Displays alerts of detected motion, digital inputs and connection status.
D	<b>PTZ Control Panel</b> Provides onscreen PTZ controls. <u>This panel is only enabled when a PTZ camera channel is selected on live view display area.</u>
E	<b>Preset Point Panel</b> Provides onscreen tour and preset points controls. <u>This panel is only enabled when a PTZ camera channel is selected on live view display area.</u>
F	Your current logged on <b>Account</b> name
G	<b>Layout Selection Buttons</b> Click to change the current layout
H	<b>Patrol</b> Click to start/stop sequence patrol
I	<b>Page Selection</b> Click on the numbers to view a row of available pages: <span style="background-color: black; color: white; padding: 2px;">1 2 3 4 5 6 7 8 9</span>

<b>J</b>	<b>Share Current View to Local</b> Click to start sharing your current view to local screen
<b>K</b>	<b>Screen Switch</b> Switch to the <b>Setup</b> or <b>Playback</b> page by clicking the tags.
<b>L</b>	<b>Current System Time</b>
<b>M</b>	<b>Toolbar</b> Lists available tools for your current page

## Set Cameras

ENR remote user interface also allows you to easily configure, add or delete cameras without individually opening the cameras' web configurator.

### Add Cameras

Go to **Setup** page → **Camera** tab.

1. As there is currently no camera existing in ENR system, click “**Add**” to starting adding the first one.

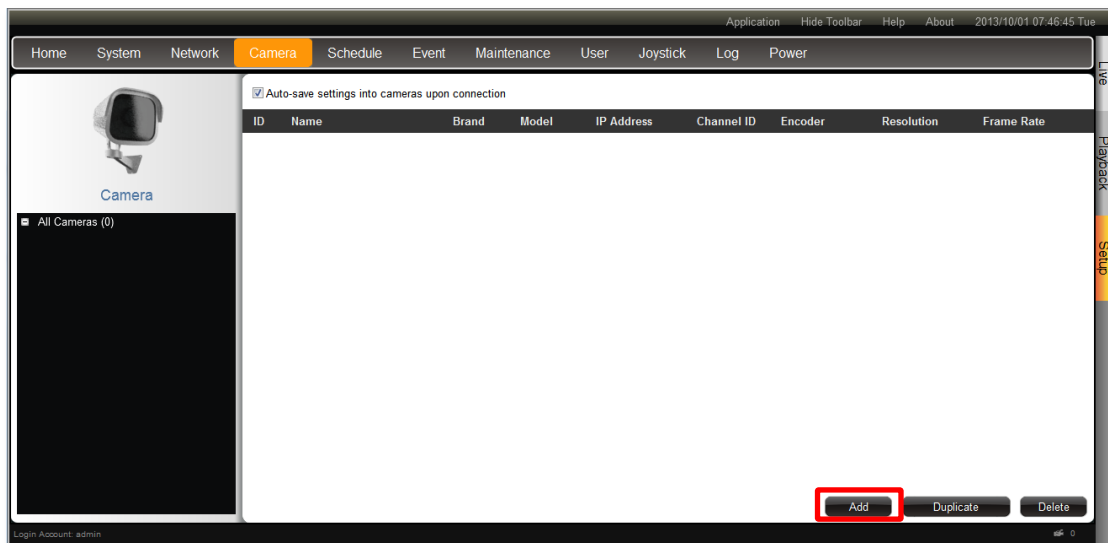

### Note

ENR will synchronize with devices upon connecting to them. To make sure the settings on ENR side are prior to those on camera sides, please check “**Auto save ENR settings into device upon connection**”. When this function is enabled, every modification you make via Camera's web configurator will be overwritten by ENR.

2. Select one method to add cameras.

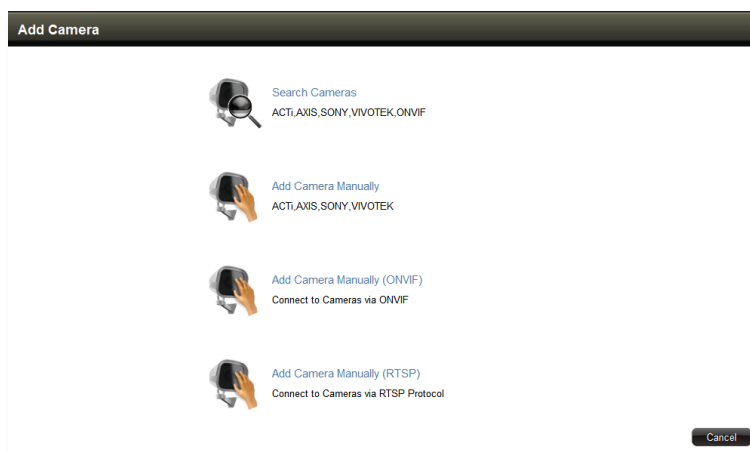



**Search Cameras**  
 ACTI,AXIS,SONY,VIVOTEK,ONVIF

**Search Cameras** method will list all the cameras (including other brand cameras and ONVIF compliant cameras) within the same network as ENR server. On

**Search Cameras** windows, input the **Account** and **Password** to access the cameras, select the manufacturer and click “**Refresh**”. After all the connected cameras are found, click the cameras and then “**Submit**” to add them.

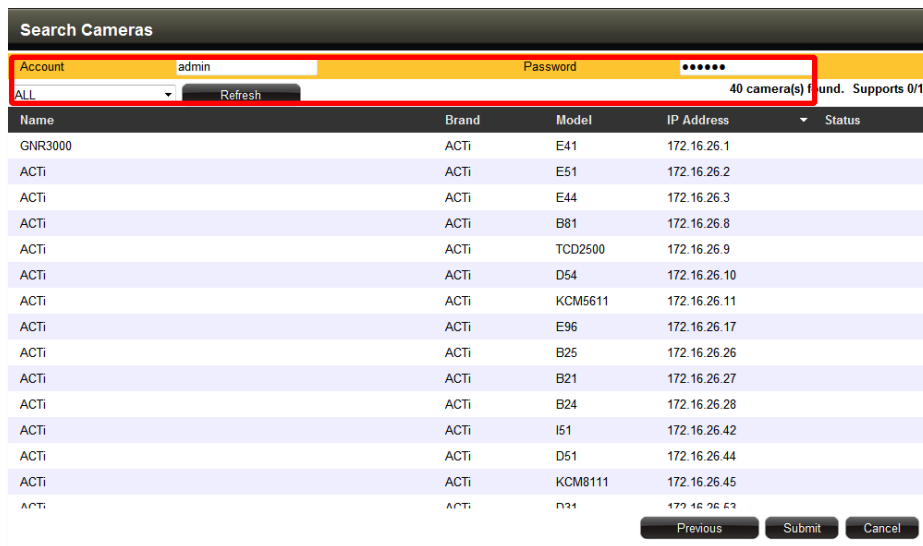

Back on the **All Cameras** list, the selected cameras are already added into ENR system and started their full-time recording service.

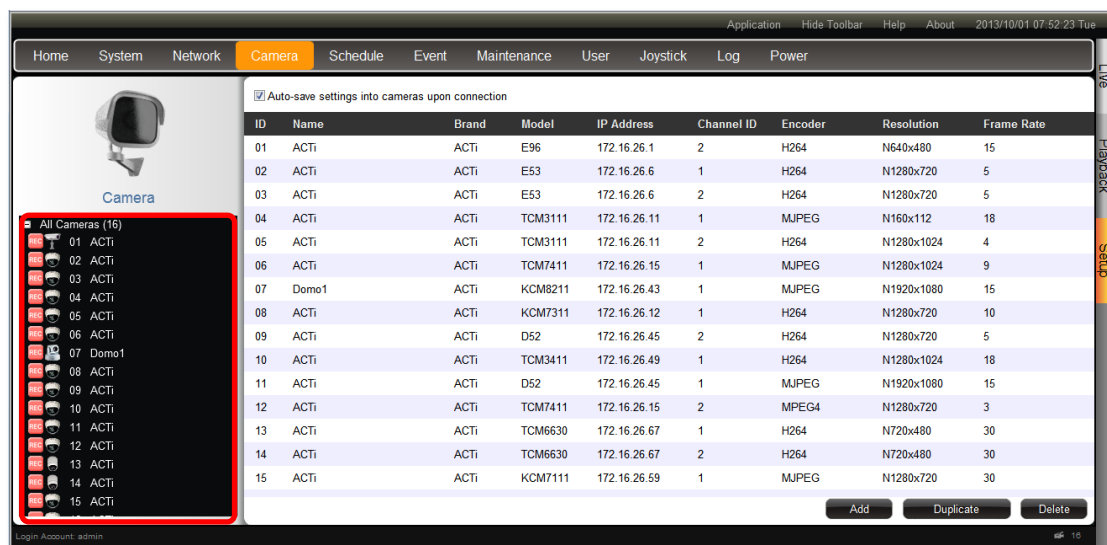

**Add Camera Manually**  
 ACTI,AXIS,SONY,VIVOTEK

You can add a device by filling its connections properties. Use this method when this device is not located in the same network segment as ENR server.

1. Fill in the connection properties such as properties **IP Address**, **Account** and **Password**,

HTTP Port, and click “Get Camera Settings”.

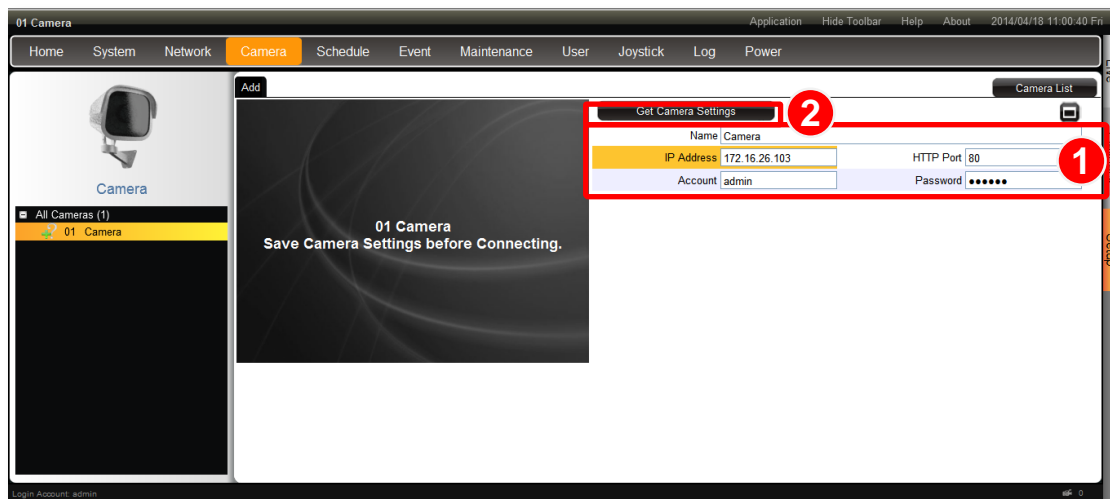

- The camera properties including **Firmware** version and **Serial Number** will appear below, you may modify other video configurations and then click “Save”.

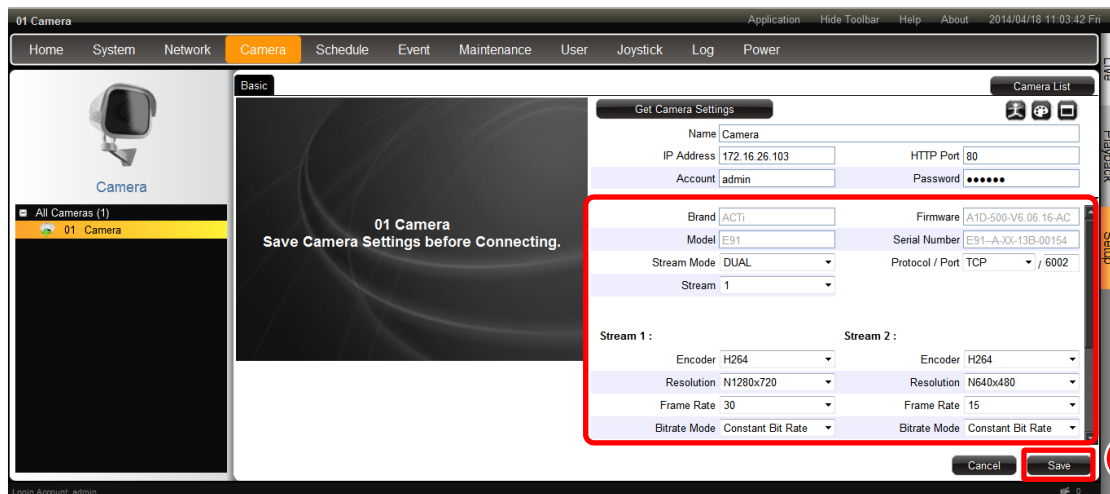

- Click “Save”, the camera’s live view will appear.

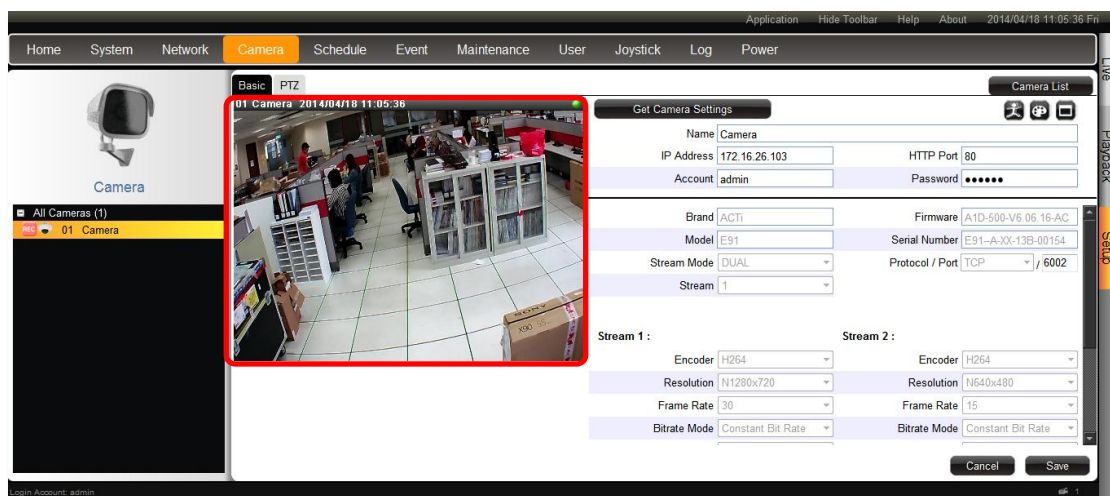





## Add Camera Manually (ONVIF) Connect to Cameras via ONVIF

You can add a device by filling its connections properties. Use this method when you want to add a specific **ONVIF** compliant device.

1. Fill in the properties, and then click **“Get Camera Settings”**.

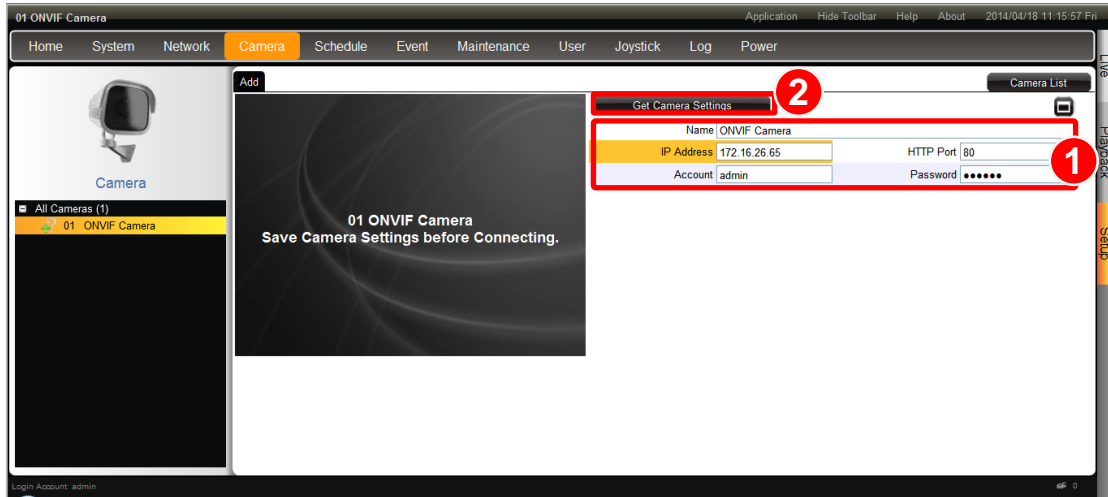

2. The camera properties including **Firmware** version and **Serial Number** will appear below, you may modify other video configurations and then click **“Save”**.

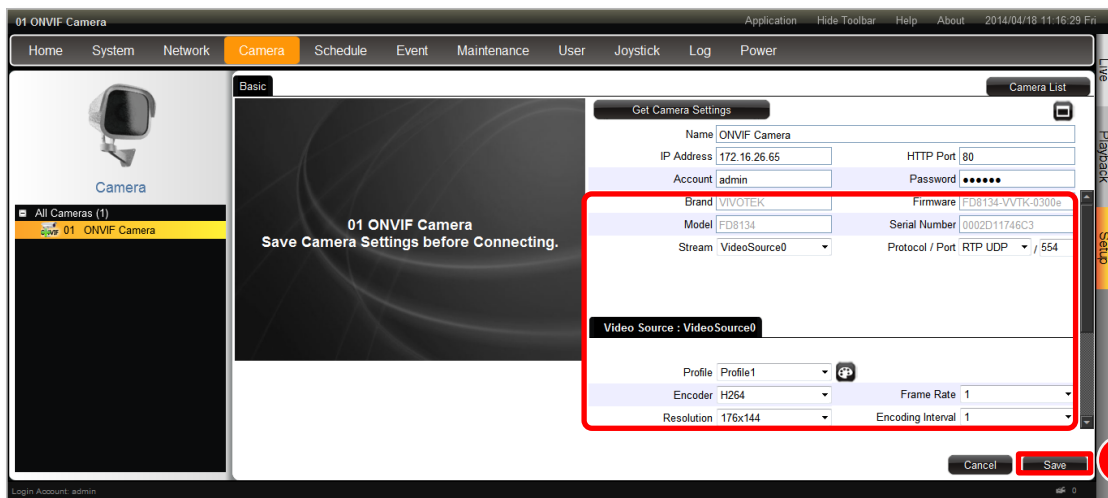

3. Click **“Save”**, the camera's live view will appear.



## Add Camera Manually (RTSP)

Connect to Cameras via RTSP Protocol

You can a specific stream via **RTSP** protocol manually regardless of its brand.

Fill in the properties, make sure you select the correct **URI** type and **Protocol** type, you can click  to open a list of default URI settings of various brands. After you click "**Save**", this stream will immediately be added to the system and displayed on live screen.

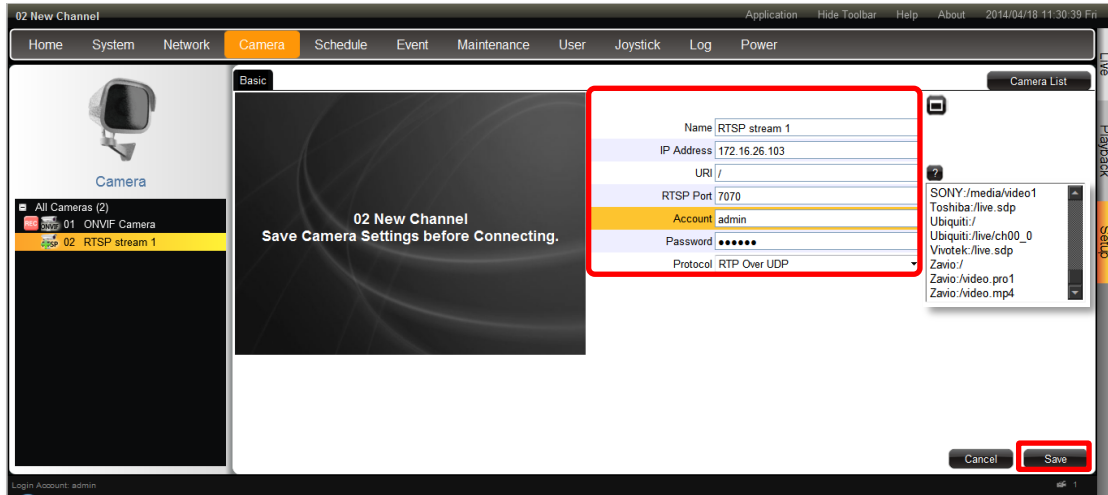

## Copy Camera Settings

You may copy an added camera's settings another channel. In this way, it is easier to manually add more than one camera of the same models.

1. On **All Cameras** list, select an existing channel.
2. Click **"Duplicate"**, the selected cameras will be duplicated to new channels. In the example shown above, **01 Camera** will be copied to a empty channel – **07 camera**.

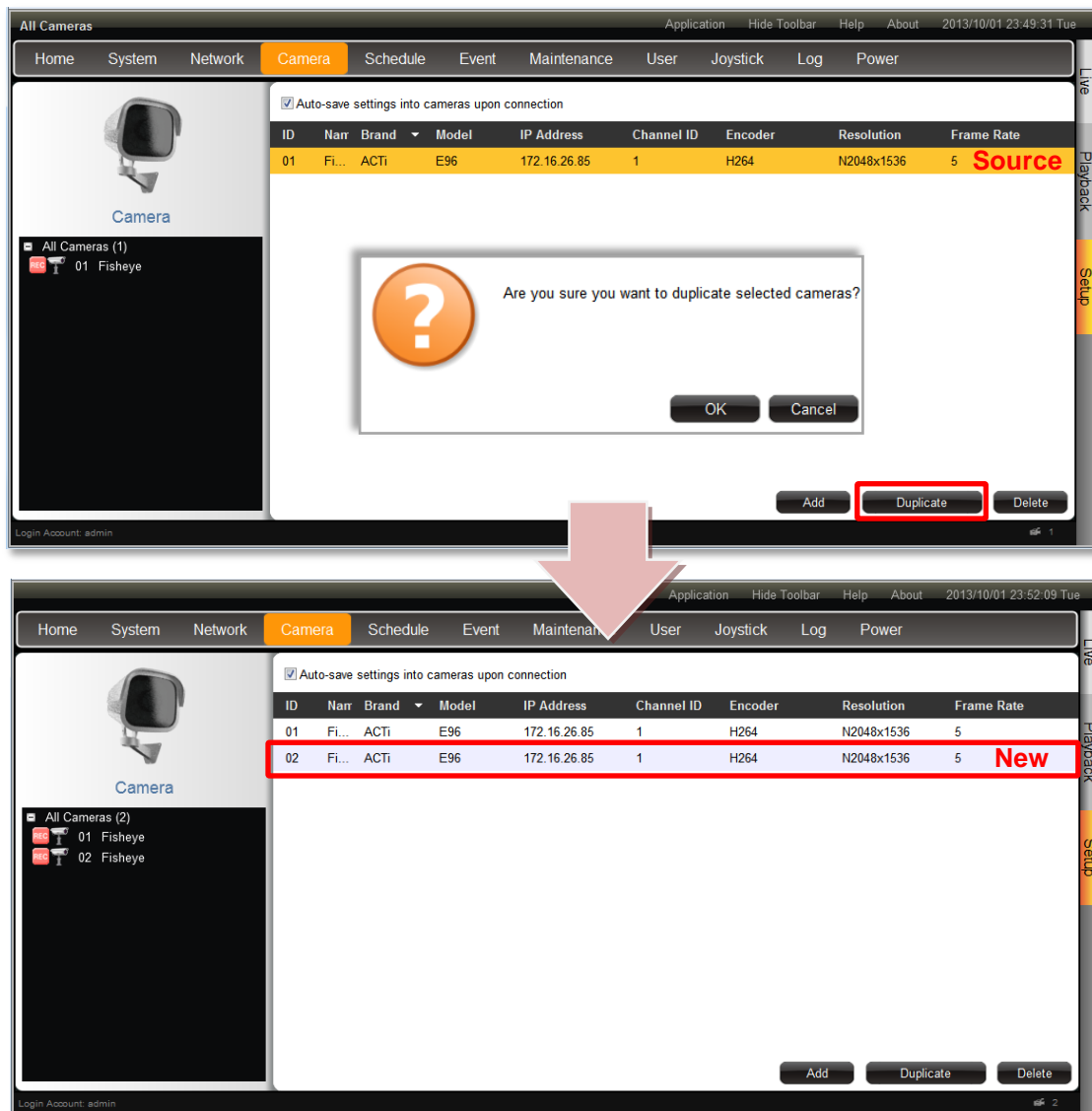

## Delete Cameras

On **All Cameras** list, select the cameras you wish to delete and click “Delete”.

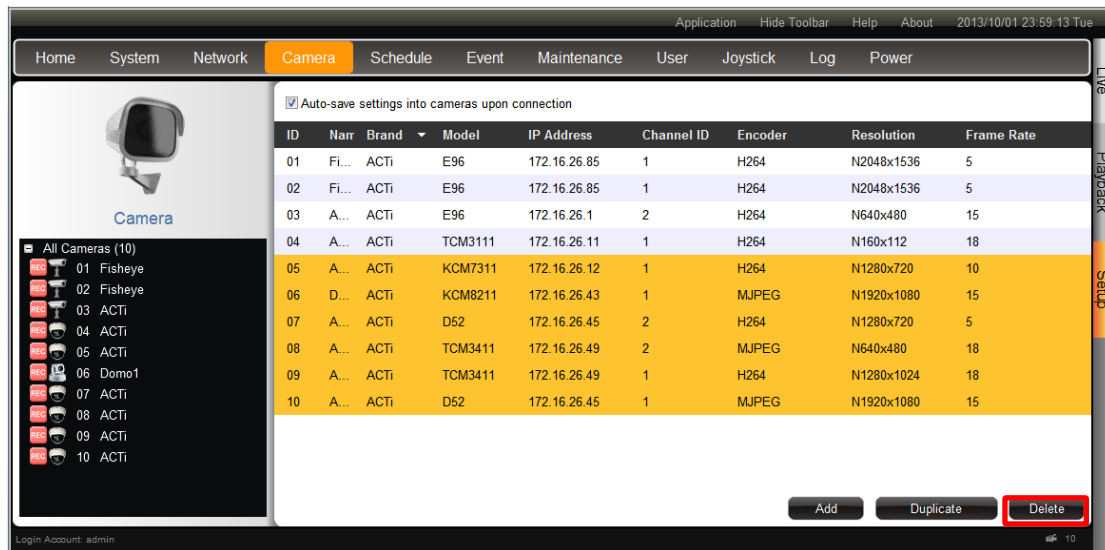

## Change Camera Settings

After the cameras are added, select a camera on **All Cameras** list to configure its individual properties.

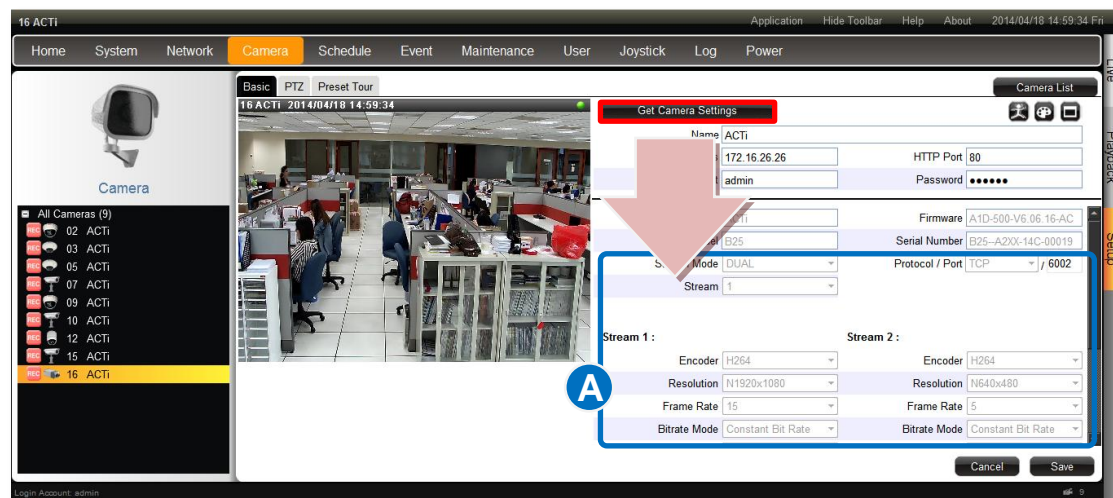

### (A) Video Format and Transmission Properties

To modify the video format and transmission properties including **Stream Mode**, **Channel ID**, **Resolution**, **Protocol**, **Encoder**, **Frame Rate**, and **Bitrate**, you will have to click “**Get Camera Settings**” first to sync with the camera first. After configuration, click “**Save**” to save this setting to camera

## (B) Motion Settings

After selecting the camera from **All Cameras list**, click . If this camera is in dual stream mode, only **Channel ID 1** (Stream 1) supports motion detection feature.

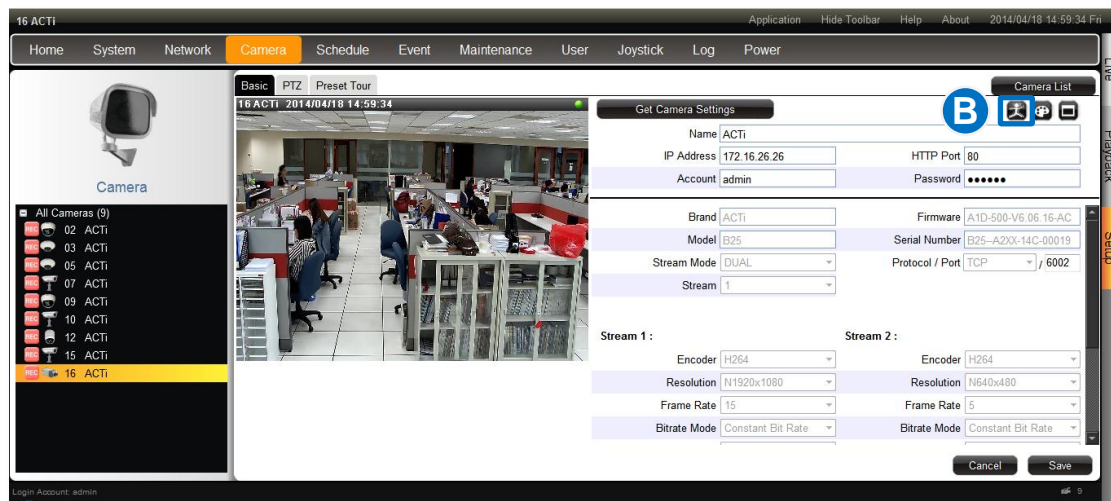

On **Motion Detection Settings** window, check **“Enable”** then click **“Motion Setup”**. To enable one motion region, check it, a color frame will appear in the view. You may start setting the detection area by adjusting this yellow frame on the view. Simply use your mouse to move and resize the frame. Click **“Apply”** to save the settings.

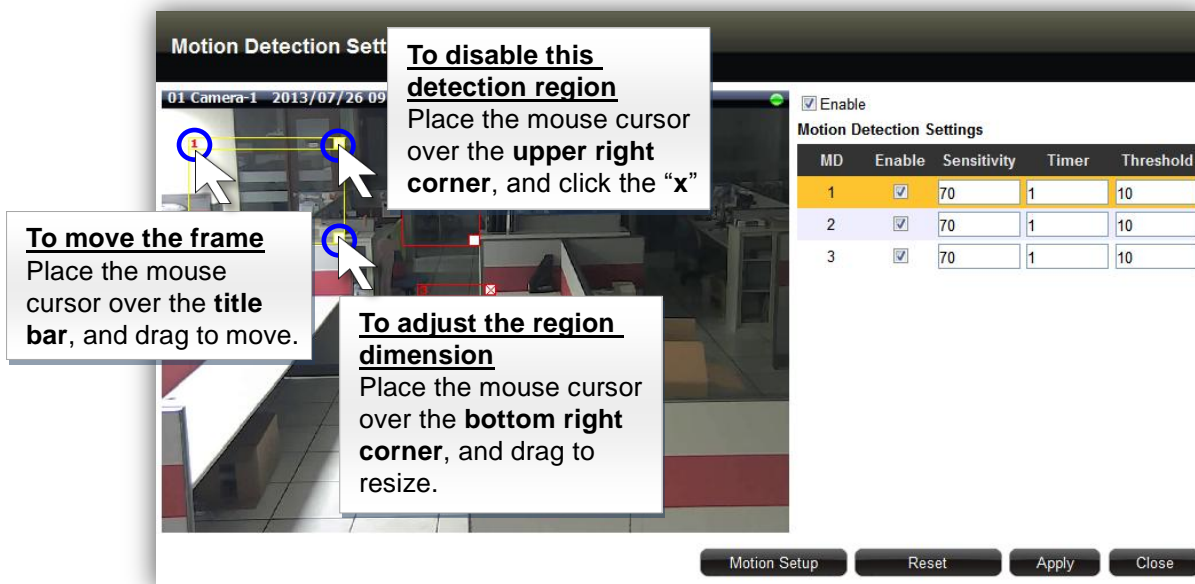

### Adjustment Attributes

Field Name	Description
<b>Sensitivity(1-100)</b>	Determines how sensitive the camera reacts to the movement. The higher the sensitivity level is, the smaller motion will trigger the alarm, but may give false alarms. Default is 70.
<b>Timer(0-300)</b>	The interval before the next motion detection can be triggered again.

<b>secs)</b>	Default is 1 second.
<b>Threshold (%)</b>	The threshold level of this motion detection region. The lower threshold level is, smaller portion of the region would be considered as motions, which is more easily to be triggered, but may give more false alarms.

### (C) Fine-tune the Image: Brightness/Contrast/Saturation/Hue

Not only details but also brightness, contrast, saturation and hue are essential factors to make images closer to real scene. For devices that support these property configurations, you may directly modify them and save to the device ENR interface. After selecting the camera from **All Cameras list**, click  .

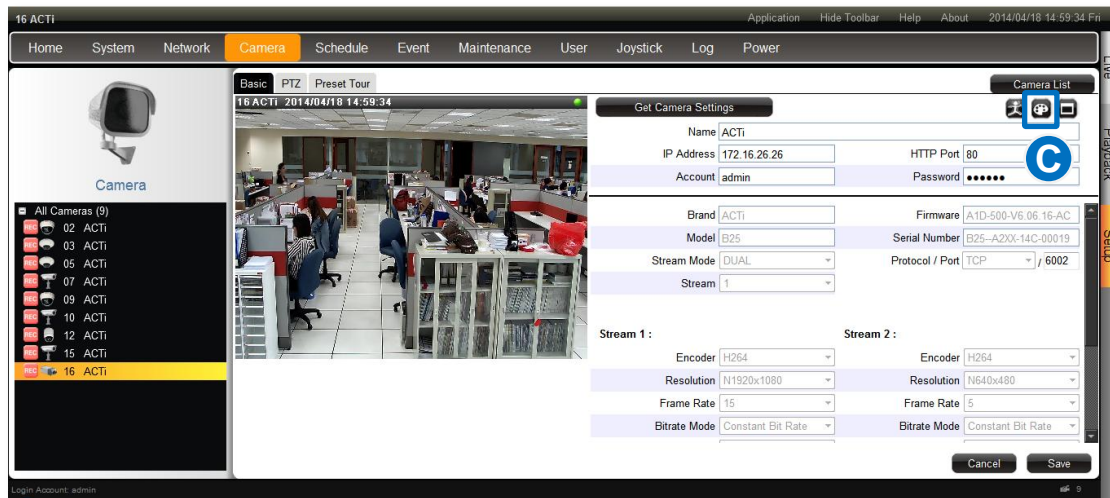

On **Video Adjustment** window, the fields available for modification (depends on models) will be enabled. Select the desired value for the field, and click **Apply**.

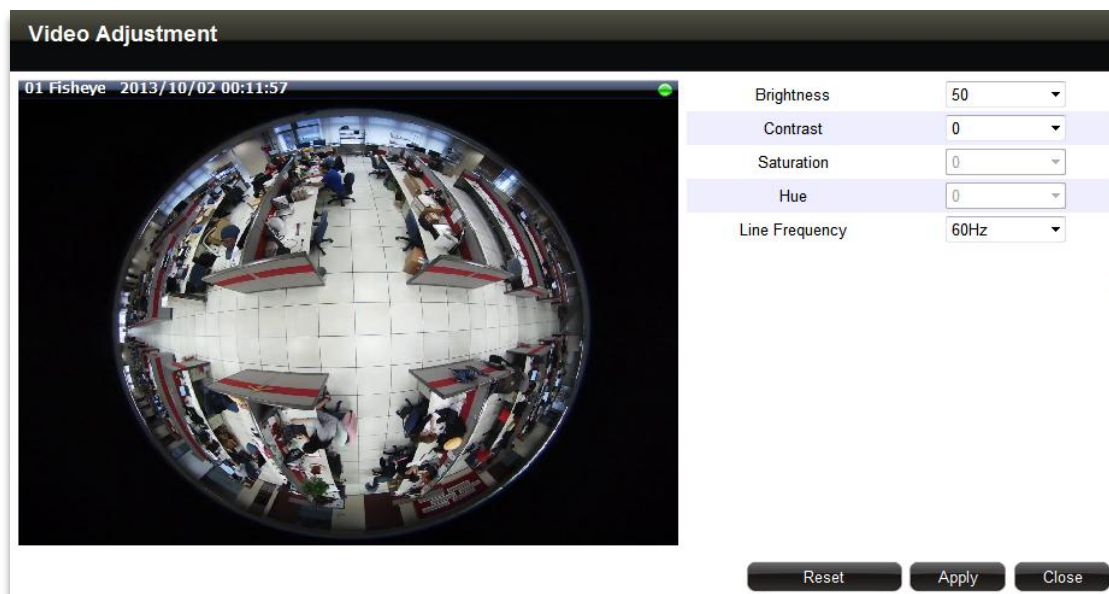

### Video Adjustment Attributes

Field Name	Description
<b>Brightness(1-100)</b>	Defines how much portion of light and of dark appear in the image. As the value increases, the image appears brighter, and vice versa.
<b>Contrast(1-100)</b>	Defines the range level between light values and dark values. As the value increases, the separation between light and dark becomes more obvious.
<b>Saturation(1-100)</b>	Defines the level of the actual color intensity. As it increases, colors appear more pure; as it decreases, colors appear more gray-out.
<b>Hue(1-100)</b>	It is the term used to refer to the pure spectrum colors. Adjust this value to find the color closest to the real scene.
<b>Line Frequency ( 50Hz / 60 Hz)</b>	The unction that adjusts the shutter speed options to match the frequency of artificial light source of given country. For example, in Europe the light frequency (due to power supply frequency of lights) is 50Hz, that is 50 flashes per second. By setting line frequency to 50Hz in such case, the shutter speed options will be proportional with light source frequency, such as 1/25s, 1/50s, 1/100s, etc. It is necessary to have the camera's Line Frequency adjusted according to the power frequency of the light source to avoid flickering effect.



## Configure PTZ Preset Points

With PTZ devices, you may define a view by where to look (through panning and tilting) and how close (through zooming) to zoom. Once these views have been saved in ENR as preset points, the device can always point to this view upon the event triggering or user's command.

Go to **Setup** page → **Camera** tab, select a PTZ camera from **All Cameras** list, and click **PTZ**. Check the **"Enable PTZ"** box to start setting the preset points.

**By default, ENR will communicate ACTi devices with the default settings, in which case you will not need to configure any property.** For certain PTZ solutions, such as a hemispheric camera in 6VGA mode or an analog PTZ device attached to an ACTi video server, you will need to enable the PTZ properties on ENR interface.

Brand	PTZ Device Types	Requires enabling of PTZ on ENR interface
ACTi	IP Speed Dome	
	IP Zoom Camera / IP PTZ Camera	
	Hemispheric / Fisheye Dome	V
	IP Camera mounted on Scanner/ Analog PTZ camera attached to Video Server	V
Others	All devices with PTZ functions	V

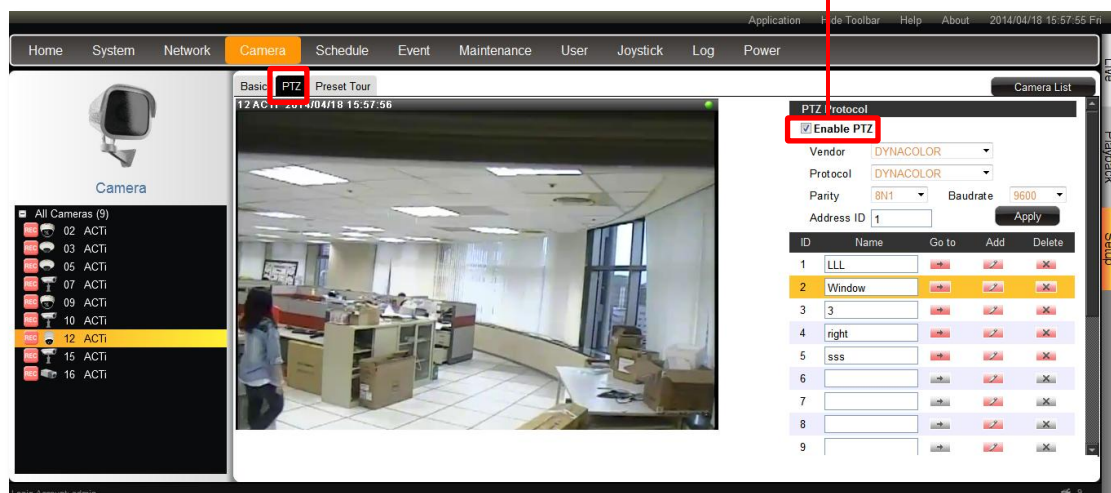

- On mini live window, use the mouse to do the following PTZ operations:
  - To execute optical **Panning** and **Tilting**, click anywhere on the live window to allow the camera to move in that direction. The length of the direction indicator is proportional to the Pan and Tilt speed. The farther you place the cursor from the center, the faster the Pan/Tilt movement.
  - To execute optical **Zoom in** or **Zoom out**, scroll the mouse wheel forward to zoom in; scroll the mouse wheel backward to zoom out.



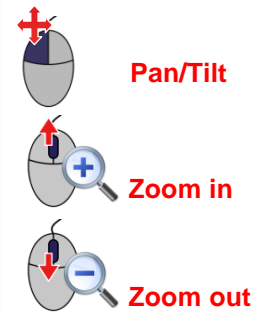
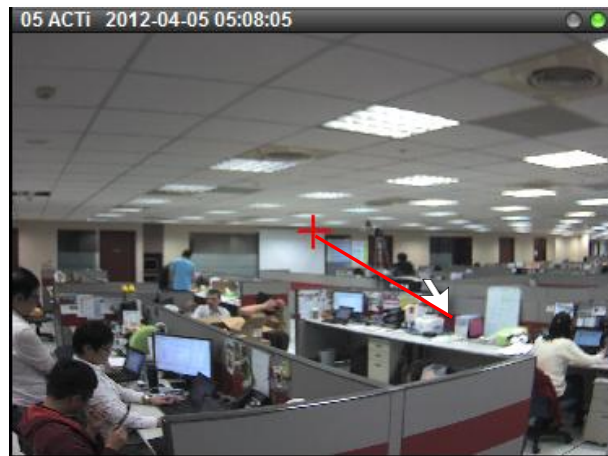

ID	Name	Go to	Add	Delete
1	Left			
2	Right			
3	Middle			
4				
5				
6				
7				
8				
9				
10				
11				
12				
13				
14				
15				
16				

## 2. Save to a Preset Point

On **Preset Point** list, select an ID, input the point name and click 

After a point is saved, click  next to its name to go to this point.

To delete this point, click 

## Configure PTZ Preset Tour

Preset Tour is a preconfigured PTZ sequence that directs the camera to cycle through multiple preset points, including where to look and how long to look at each location. With this preset tour, your PTZ device can perform an automatic patrol to scan through your cared areas.

Before setting up Preset Tours, please make sure you have configured PTZ settings and set PTZ Preset Points. To start:

1. Go to **Setup** page → **Camera** tab, select a PTZ camera from **All Cameras** list, and click **Preset Tour**.
2. Select a tour from **Tour1~Tour32**, input its **Name**, pick a preset point, define its **Dwell time** and click “**Add**”, this preset point will be added to the tour. Continue to add other preset points in your desired movement sequence and click “**Save**”. After a tour is saved, it is available on **Live** page→**Preset Point** control panel.

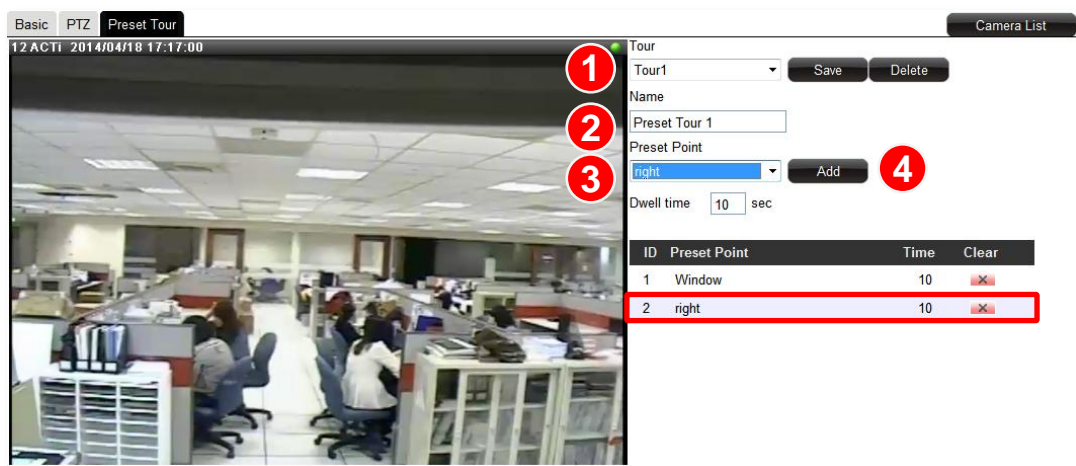

## Configure Fisheye Cameras

With hemispherical lenses, fisheye cameras generate images at up to 360-degree width, which can cover all four corners of a room or both sides of a long aisle. As the original image captured by wide-angle lens is much distorted, to suit most monitoring purposes, the **Dewarping** process is required to alter the uneven lines and shapes before the images are displayed. Nowadays, the fisheye cameras come in two types in terms of the image-correction capability:

- Fisheye Cameras **with** in-camera dewarping function

The dewarping takes places in camera before the video is output to NVR server. Since the image correction counts on the camera itself, NVR server will not bear much extra loading, which benefits the system requiring many of these fisheye cameras (e.g. ACTi KCM-3911, KCM-7911)

- Fisheye Cameras **without** dewarping function

These fisheye cameras output only original global images, relying on software algorithm processing provided by NVR sever to correct the images. They are suitable for a system with limited bandwidth, for NVR server processes and responds to User's ePTZ manipulation or demands for changing view modes immediately, without waiting for camera side to deliver a new frame (e.g. ACTi E96).

ENR's software algorithm can perfectly corrects the original fisheye images, generating **6 specific fisheye view modes** from User's usual perspective. As a remote client, you may

- Select a desired fisheye view mode on Live screen and manipulate virtualized ePTZ operation with onscreen controls.
- Export the video clip of your desired fisheye view mode.

To make use of ENR's dewarping features for your fisheye cameras, please







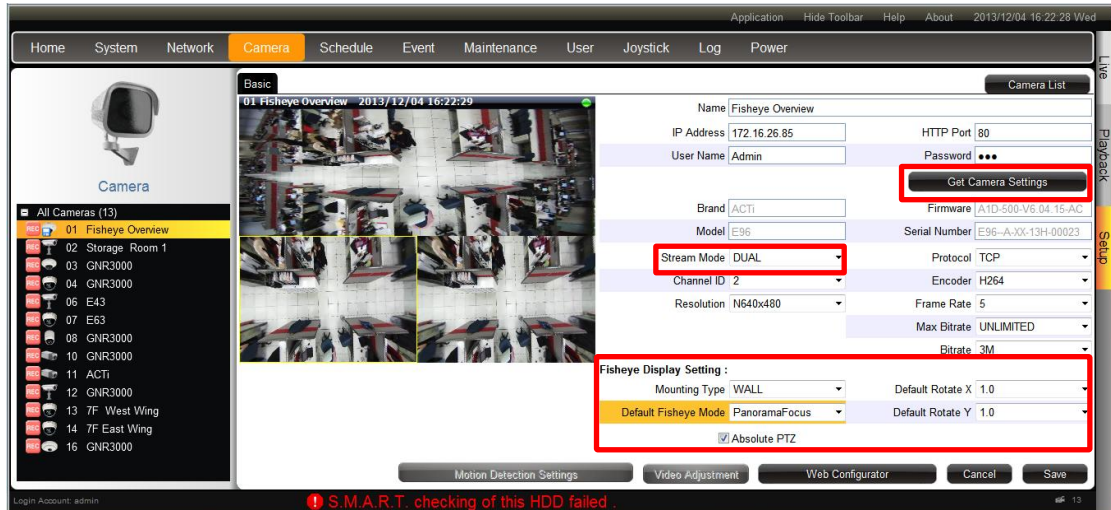

### 1. Adjust **Video Quality Settings**

After the fisheye camera is successfully added, go to **Setup** page → **Cameras** tab, select the device and then click "**Get Camera Settings**", make sure you set the **Stream Mode** as "**FISHEYE**" for a hemispheric camera ( KCM-3911, KCM-7911 ). This is to make sure this hemispheric camera is outputting fisheye original video stream as a mini fisheye dome camera does.

### 2. Adjust **Fisheye Display Settings**

Select your **Mounting Type**, and then **Default Fisheye Mode**. For a fisheye mode containing panorama view, you may want to configure the **Default Rotate X** (width of view) and **Default Rotate Y** (height of view) configurations.

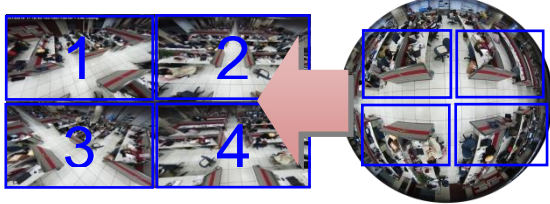

Fisheye Mode	Description	PTZ Navigation
<p><b>Original View</b></p>	<p>The very raw fisheye view</p> 	<p>Digital PTZ</p>
<p><b>Dewarping</b></p>	<p>One large user-defined cropped area</p>  	<p>ePTZ</p>
<p><b>Panorama</b></p>	<p>360-degree panorama view for ceiling mount 180-degree panorama view for wall mount</p>    	<p>Digital PTZ</p>
<p><b>Double Panorama</b></p>	<p>Two 180-degree panorama views</p>  	<p>Digital PTZ</p>

<p><b>Panorama /Focus</b></p>	<p>One panorama view Two small user-defined cropped regions</p> 	<p>ePTZ</p>
<p><b>Quad</b></p>	<p>Four small user-defined cropped regions</p> 	<p>ePTZ</p>

After the configuration is done, remember to click “**Save**” to save the settings.

**Note**

1. Local Live and Playback can only display the original video stream output from a fisheye camera.
2. Whichever fisheye view mode you are watching on remote interface, ENR will record the original video stream output from a fisheye camera; however, you may export the video in any desired view mode.

## Set Recording Schedule

For the recording schedule, ENR supports **Schedule recording**, **Event recording** and **Event Speed-up Recording** modes, which are set up on a week-based timetable; the event-handling schedule is configured here.

On ENR, you can configure camera's recording schedule on 7 days / 24 hours basis. The schedule is split into segments of one-hour-length. By default, once a device is added to the system, its schedule is automatically set to full-time schedule recording and event handling. You should configure it according to your system plan.

Go to **Setup** page → **Schedule** tab, and select a camera to configure its recording schedule.

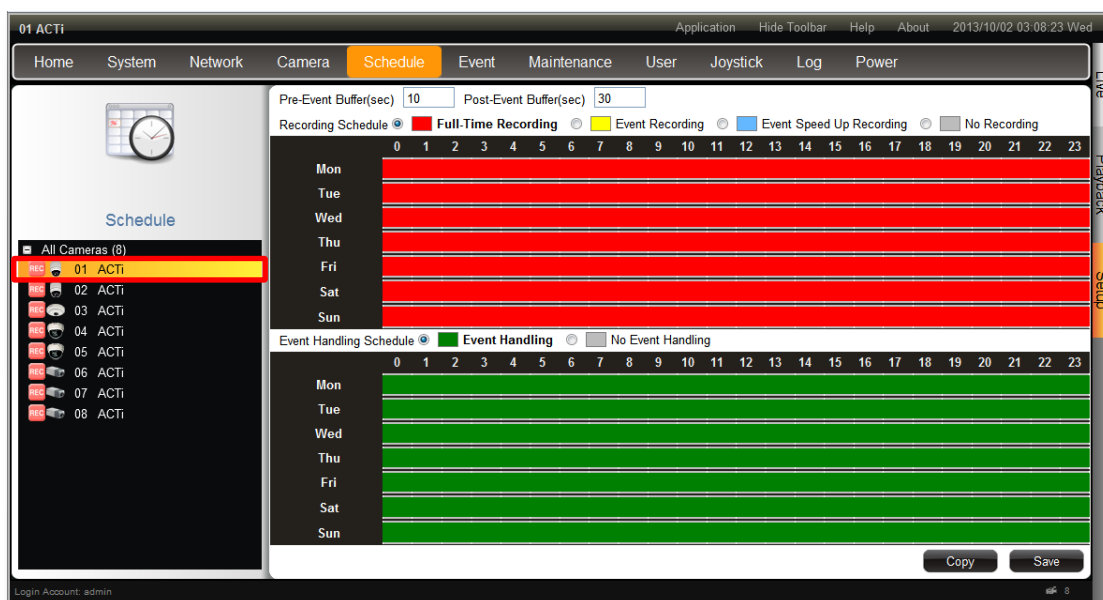

### Event-Recording File Length

Before setting the recording schedule, you may define the length of an event recording. To do this, configure the following properties shown as below, which will make an event recording as long as 10+30 second:

Pre-Event Buffer(sec)  Post-Event Buffer(sec)



Field	Description
<b>Pre-event Recording Buffer (sec):</b>	ENR keeps a short cache of video received from devices. If an event is triggered, ENR will automatically store the pre-event buffer along with the recording of the event itself.
<b>Post-event Recording Buffer (sec):</b>	This will determine how long after the event is triggered should be included in the event recording file.

## Set the Recording Schedule

1. Select a recording type.

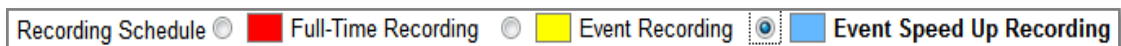

Field	Description
<b>Full-Time Recording</b>	Continuously record at the video frame rate you define in <b>Camera Settings</b> .
<b>Event Recording</b>	Only events are recorded, at the video frame rate you define in <b>Camera Settings</b> .
<b>Event Speed Up Recording</b>	Continuously record everything at 1FPS, when an event occurs, the frame rate will switch to the value you define in <b>Camera Settings</b> , and automatically switch back to 1FPS after the event ends.

2. On the recording schedule time table, click and drag to set time period.

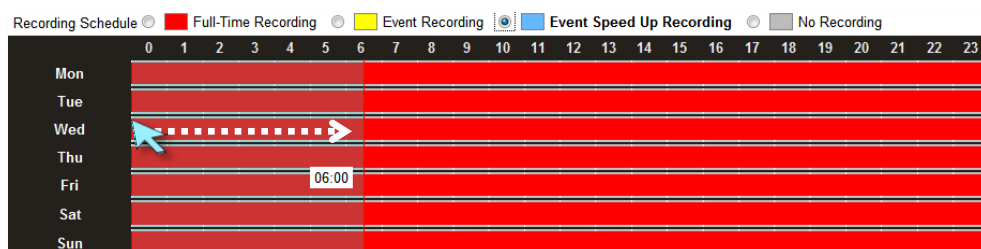

3. Click "Save"
4. To delete the recording configuration, select  **No Recording** and drag on the desired section on time table.

## Set the Event Handling Schedule

The **Event Schedule** defines when the event handling is activated. To set the event rules, please refer to [Set Event Rules](#) on page 123. By default, the event handling is full-time activated; you may disable it for a certain period.

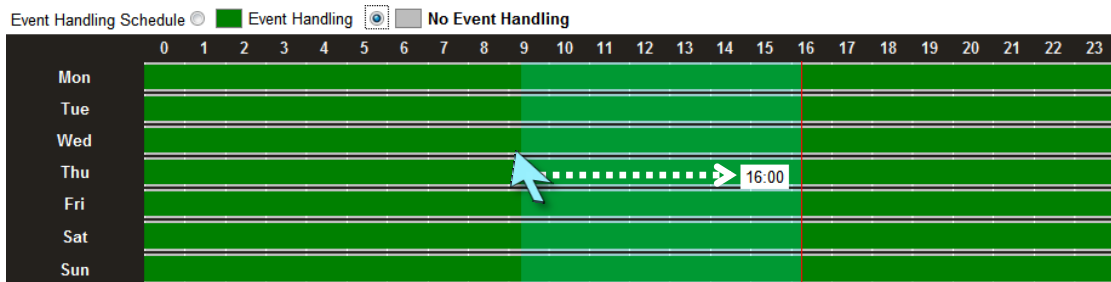

1. Click   No Event Handling
2. Drag over the Event Handling Schedule time track to disable the event handling service.
3. Click “Save”.

## Copy Schedule

You may copy a camera’s schedule setting to other multiple cameras. This saves much your time on configuring the schedules camera by camera. On the bottom of this page, click “Copy” to bring up **Copy Schedule** window.

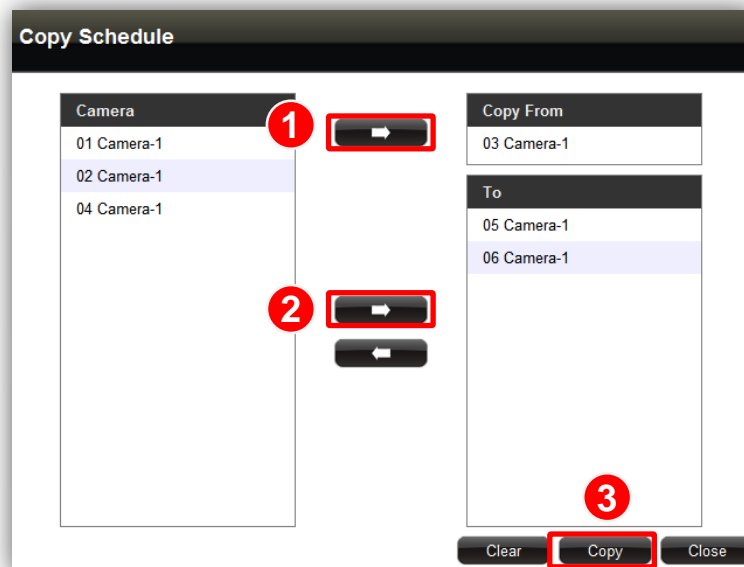

Select one camera as the source of schedule, and add other cameras to the “To” field. Click “Copy” to commit changes.



## Event Management

ENR can react to events occurring on the storage disk and camera site based on the rules you set here.

### Set Event Rules

Go to **Setup** page → **Event** tab, and select a **camera** or **System** to set Event rules.

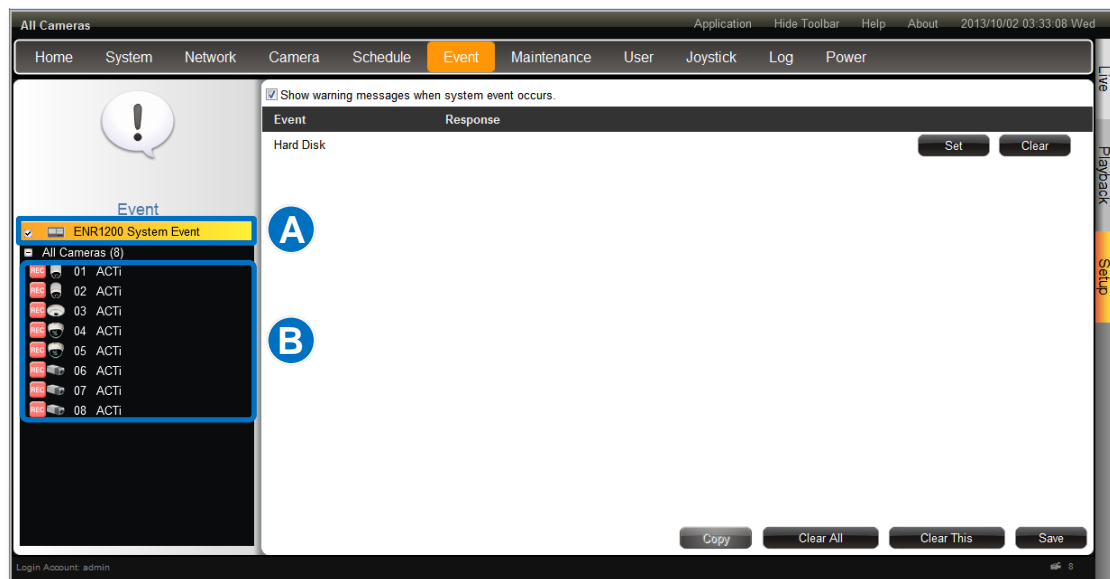

#### **A** Set System Event rule

Whenever any hard disk goes into abnormal status, ENR will trigger a response based on the rule you set.

1. Click **“Set”** to enter the rule content.



2. Select your desired response type, configure the properties and then click **“OK”** to save this rules. There are two types of response for a system event: **Beep** and **Send Mail**.

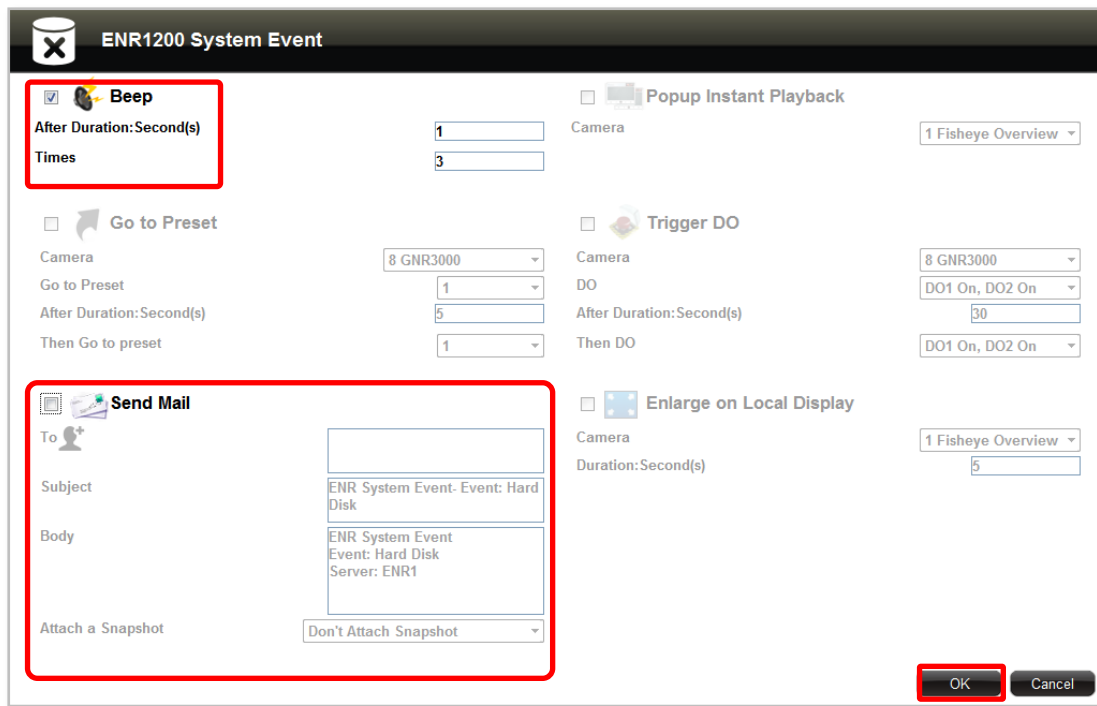

## B Set Camera Event rule

Whenever any encounter certain events (including detected motions, detected DI triggers, network loss and network recovery) ENR will trigger a response based on the rule you set.

1. Select a camera and then click “Set” of your desired event type.

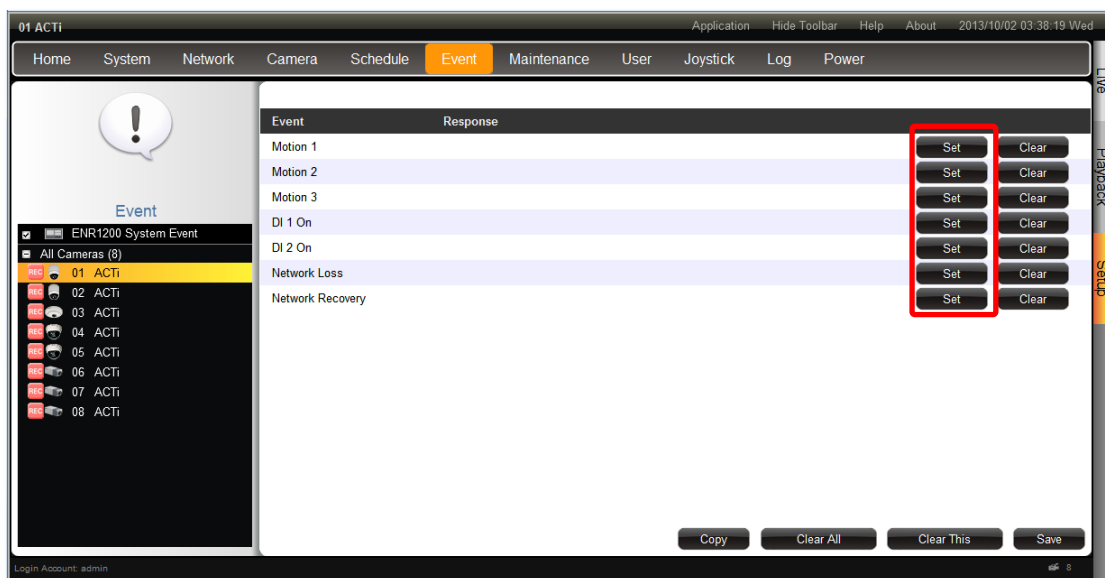

2. Select your desired response type, set the details and click “OK” to save the rules.

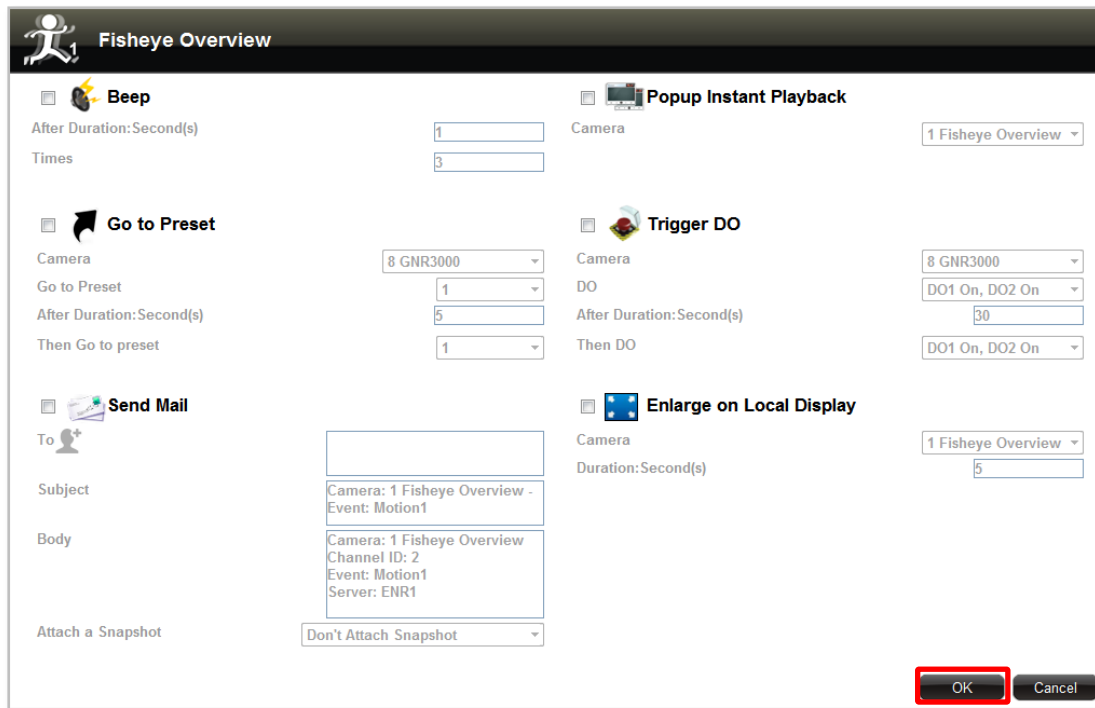

The screenshot shows the 'Fisheye Overview' configuration window with the following settings:

- Beep:** After Duration: 1 Second(s), Times: 3
- Go to Preset:** Camera: 8 GNR3000, Go to Preset: 1, After Duration: 5 Second(s), Then Go to preset: 1
- Send Mail:** To: [Empty], Subject: Camera: 1 Fisheye Overview - Event: Motion1, Body: Camera: 1 Fisheye Overview, Channel ID: 2, Event: Motion1, Server: ENR1, Attach a Snapshot: Don't Attach Snapshot
- Popup Instant Playback:** Camera: 1 Fisheye Overview
- Trigger DO:** Camera: 8 GNR3000, DO: DO1 On, DO2 On, After Duration: 30 Second(s), Then DO: DO1 On, DO2 On
- Enlarge on Local Display:** Camera: 1 Fisheye Overview, Duration: 5 Second(s)

Buttons: OK (highlighted with a red box), Cancel

To delete a certain response, simply de-select it from the response window, and then click “OK”.

3. After all the rules are set, click “Save” on Event tab to save all settings.

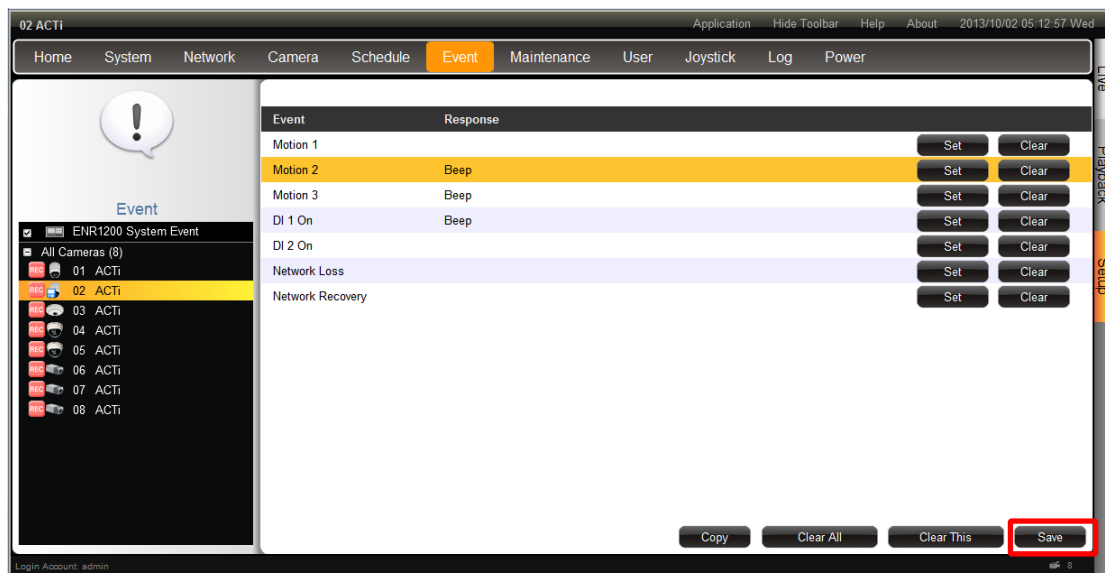

The screenshot shows the 'Event' configuration window with the following table:

Event	Response	Set	Clear
Motion 1		Set	Clear
Motion 2	Beep	Set	Clear
Motion 3	Beep	Set	Clear
DI 1 On	Beep	Set	Clear
DI 2 On		Set	Clear
Network Loss		Set	Clear
Network Recovery		Set	Clear

Buttons: Copy, Clear All, Clear This, Save (highlighted with a red box)

## Response Types

ENR supports the following reaction types:

- **Popup Instant Playback**

ENR will pop up a small window on **Live** screen to play the 10-second period ahead of event.

You will choose a specific camera whose recording is to be played.

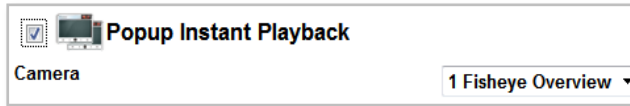

- **Go to Preset**

For the use of PTZ cameras to make movements toward certain triggers, please configure the preset points (refer to [Configure PTZ Preset Points](#) on page 114) before you set the event rule. You have to select which PTZ camera to make the movement, then the preset points and duration time between them.



- **Beep**

ENR device can play beep sound upon being triggered by events. Input the duration time and prepeat times of the beep.



- **Trigger DO**

Set the DO to become **ON** or **OFF** upon trigger, only the devices supporting DO functions are available. Select the device whose connected DO(s) will be triggered. You may select one DO to be activated after the other and the duration time between them.

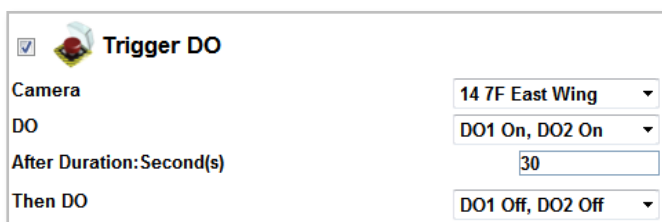



## ●Send Mail

The response enables ENR to send e-mail notifications via SMTP service. Fill in the mail recipient's e-mail address in "To" field, notification title in "Subject" field and mail body in "Body" field, then choose a camera whose snapshot will be attached from **Attach a Snapshot** dropdown list.

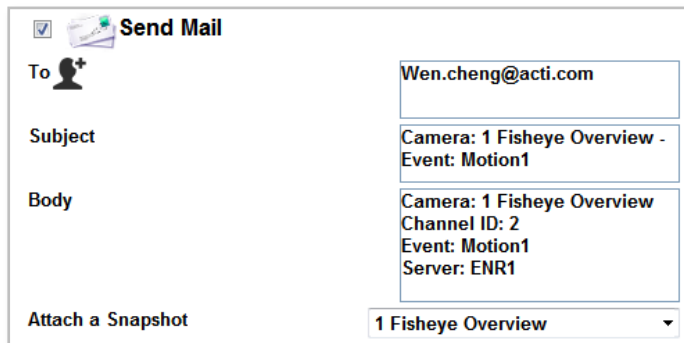
To enable this service, you have to configure the SMTP settings (please refer to [Set E-mail Notification Service](#) on page 100) beforehand.



 **Send Mail**

To 

Subject

Body

Attach a Snapshot

## ●Enlarge

**Local Live** screen will display certain channel view in full screen for a while when the system is triggered. Select the camera whose live view will be enlarged on **Live** screen and the duration time.



 **Enlarge on Local Display**

Camera

Duration: Second(s)

## Copy Event Rules

You may copy a camera's event rules to other multiple cameras. This saves much your time on setting up rules one by one. On **Event** tab, click **"Copy"**

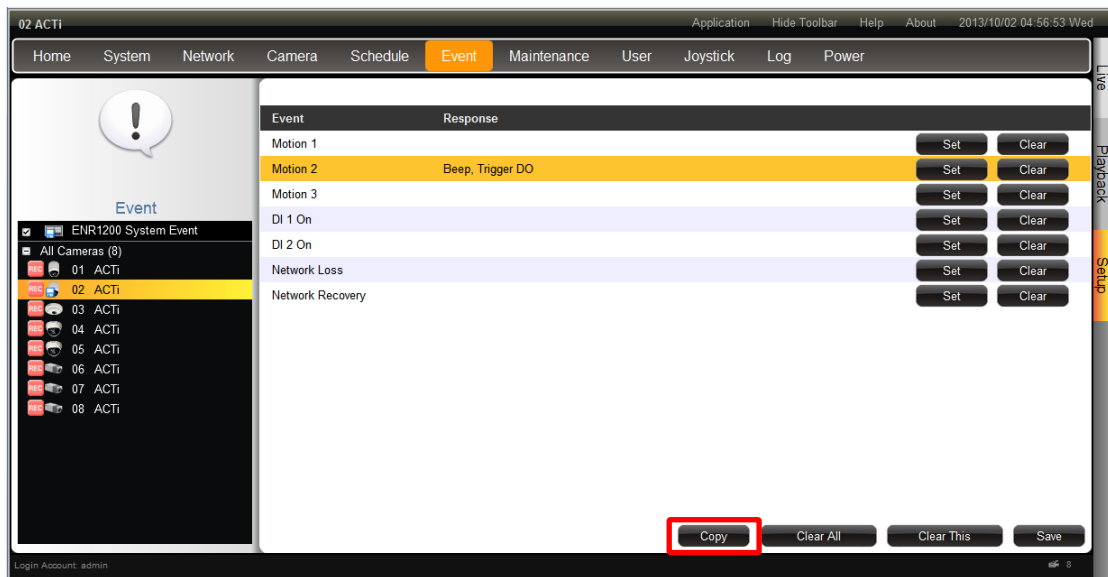

Select one camera as the source of schedule, and add other cameras to the "To" field. Click **"Copy"** to commit changes.



## Clear Event Rules

On **Event** tab, you may select an event rule under certain camera, and click **“Clear”** to delete it.

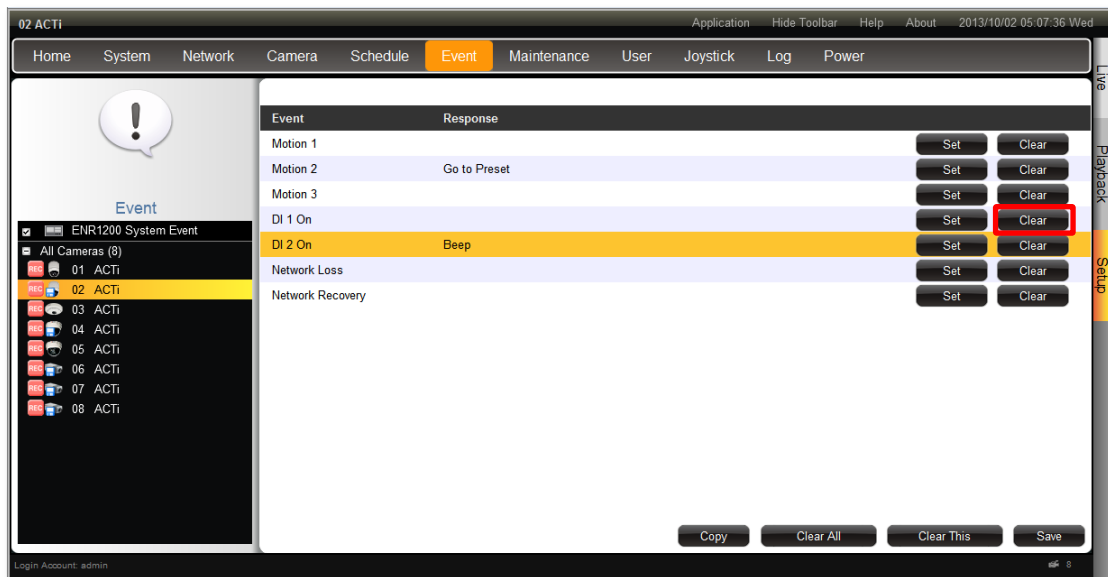

To directly clear all event rules set under a certain camera, click **“Clear This”**.

You may also clear all the rules in ENR system by clicking **“Clear All”**.

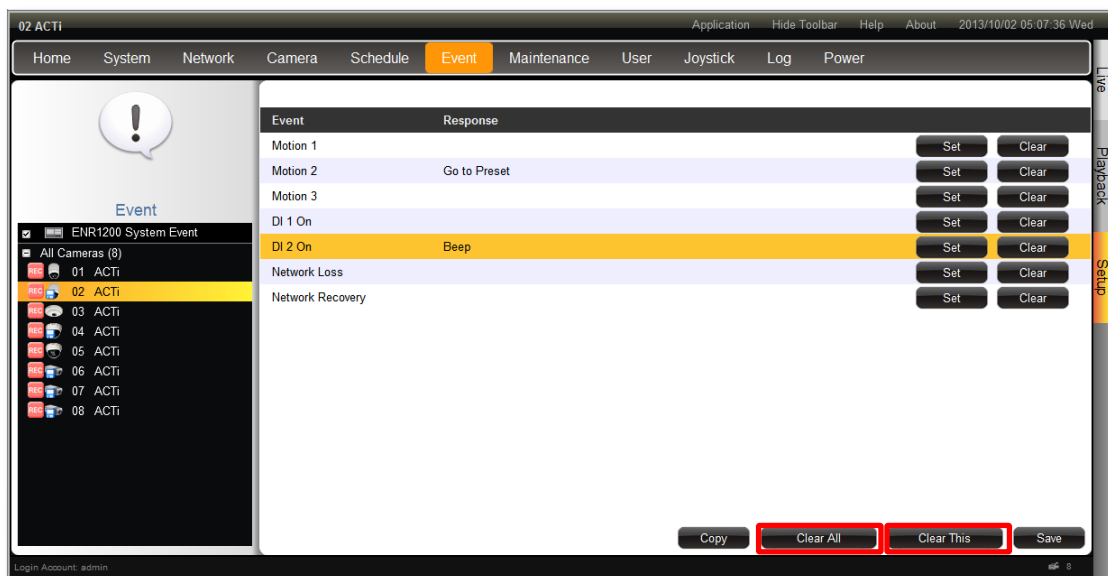

Please remember to click **“Save”** after deleting any rule.



## Disk Management

ENR keeps the recordings on SATA hard disks installed in it. Whenever recording is taking place, ENR writes data to one of the disks, and switch to the other as the original one is full. Once the available space of the whole system is less than the reserved size, ENR will start deleting the oldest file to make the amount of space allowing each active channel to record for another 10 minutes.

You may observe the disk memory and recording status on **Storage** page.

Go to **Setup** page → **System** tab → **Storage**. The connected storage devices will be shown in the **Storage Device** list.

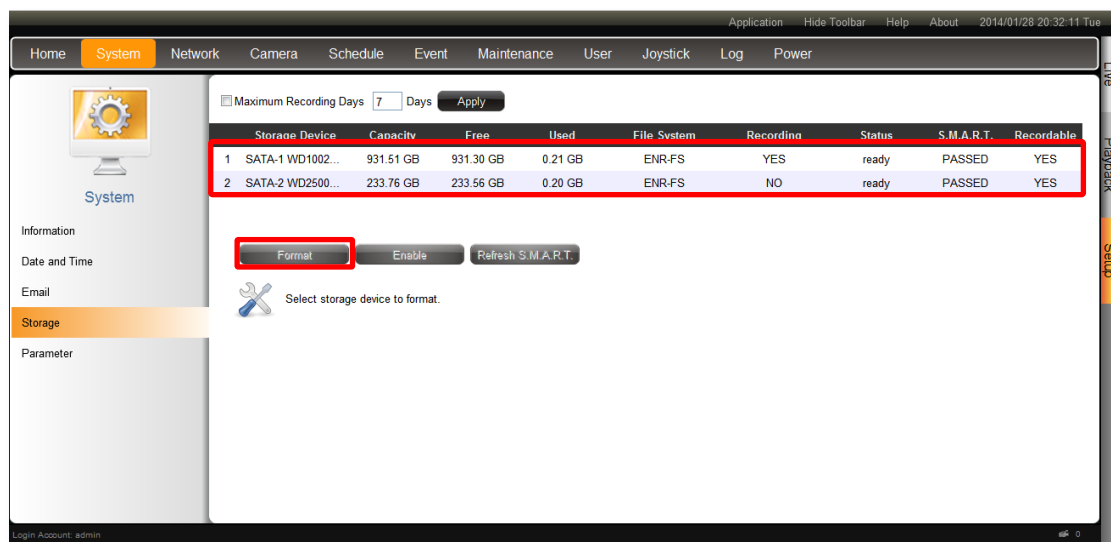

### Format Hard Disks

Select a disk and click **Format**.

You may execute disk formatting toward a newly-installed disk. You should follow the installation procedures (refer to [Install the Hard Disks](#) on page 22 ) to format the disks before ENR system start carrying out the surveillance task, for a disk that is not in ENR file system format is not ready for recording. Please note that the system will stop recording during the disk formation.

If you have to format a disk having been recording for a while, it is suggested that you export important video and system log in advance.

## Set Maximum Recording Days

ENR can keep recording files for a certain number of days defined by you. Set this rule if you have more concern about how long the recordings are kept, especially when you do not want the old recordings to stay longer in the system than a certain period. By default, this rule is not activated, to modify it, check the box to input a number between **1~999** and click **“Apply”**.

For more deletion rules explanation, please refer to Storage Settings - Set Recording Deletion Rule on page 61.

## Check Disk Status

Hard disk failure often comes after detectable signs and thus can be predicable, thus it is important to detect these signs long before they really cause disk failures.

ENR performs **S.M.A.R.T.** Disk check on 24-hour basis since last check. This technology enables a system to monitor the disk status and anticipate disk failures, helping the system administrator to prevent from unexpected outage and data loss.

You may manually perform an instant **S.M.A.R.T** check by clicking **“Refresh”**.

Once the **S.M.A.R.T** status of disk appears **“WARNING”**, **“FAILED”**, or **“UNKNOWN”** instead of **“PASSED”**, it is not reliable for recording, and may fail when the number of bad sectors on the disk has grown high enough. Please

1. Click **“Disable”** next to **Recordable** status to stop the system from saving recording into it.
2. Immediately export important video and system log, and then replace the disk following the instructions [Manage Abnormal Disks](#) on page 63.

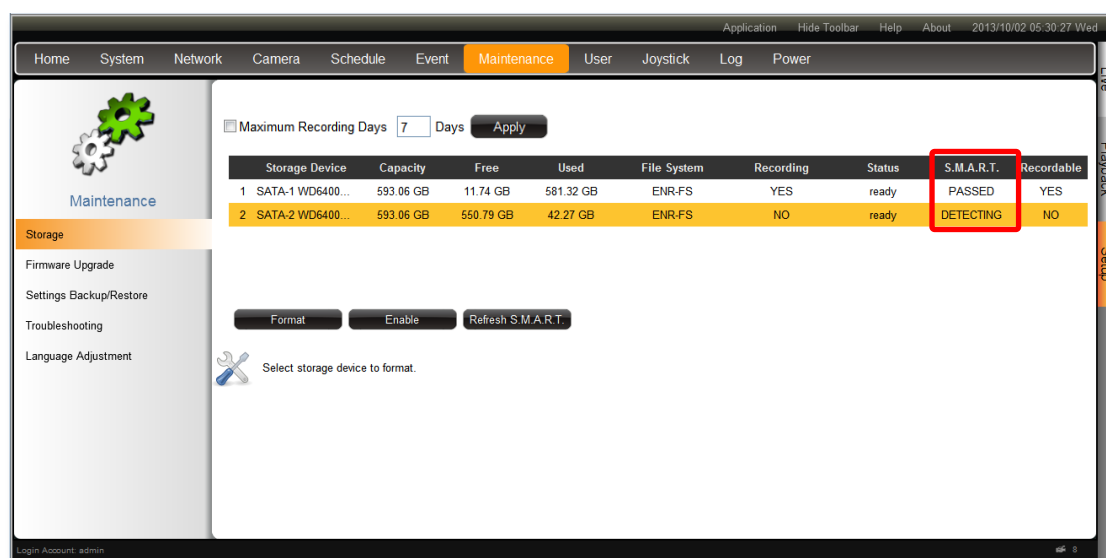

## Upgrade Firmware

You may check ACTi corporate website for latest ENR firmware package and download it. Unzip the package and save the \*.upg file to your client computer.

1. Make sure there is a recordable hard disk installed in ENR or a USB disk with at least 200MB space connected to ENR.
2. Go to **Setup** page → **Maintenance** tab → **Firmware Upgrade**. Click “**Browse**”, find the target \*.upg file and click “**Open**”.
3. Click “**Upgrade**”.

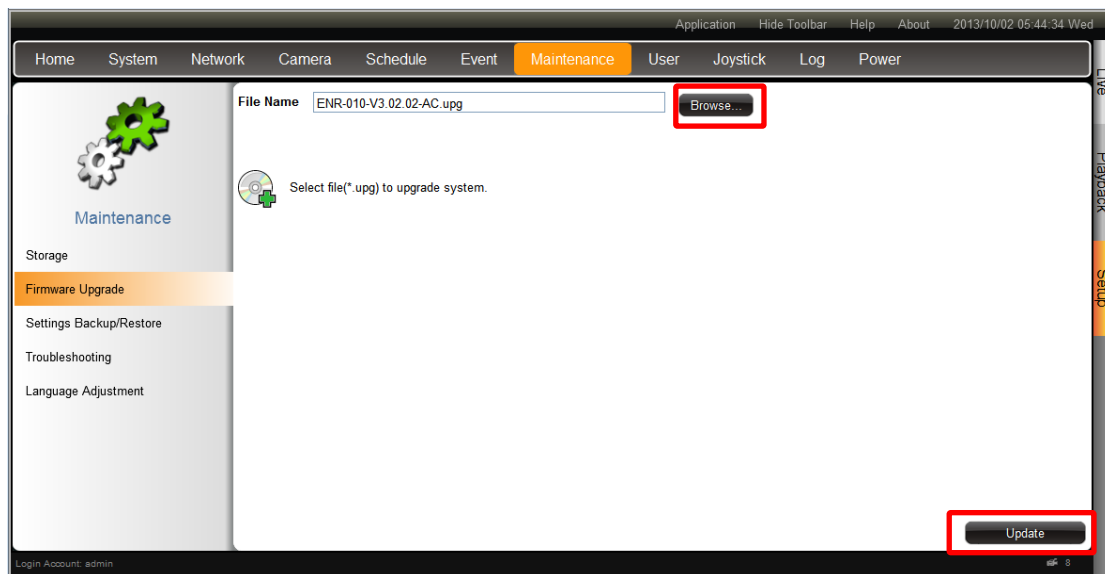

During upgrading, the system will stop every other activity including recording and event handling. The system will auto-restart after the upgrading completes.

As upgrading has started, **DO NOT cut off the system power or eject the USB disk until ENR restarts.**

## Backup / Restore Settings

Making regular system backups is always recommended in case of unexpected disasters or accidents that may damage ENR server.

ENR server can create a backup file of the whole system settings as

**Backup\_[yyyymmdd].nvr** file and save it to your client computer within one click. The backed up settings include the following properties: (1) **System Settings** including **System Name, Date & Time, Network, Email, Mouse and Keyboard**, (2) **Camera Settings**, (3) **Schedule Settings**, and (4) **Event Management**.

### Backup

To start backing up system setting, please insert a USB disk into ENR first.

1. Go to **Setup** page → **Maintenance** tab → **Settings Backup / Restore**.

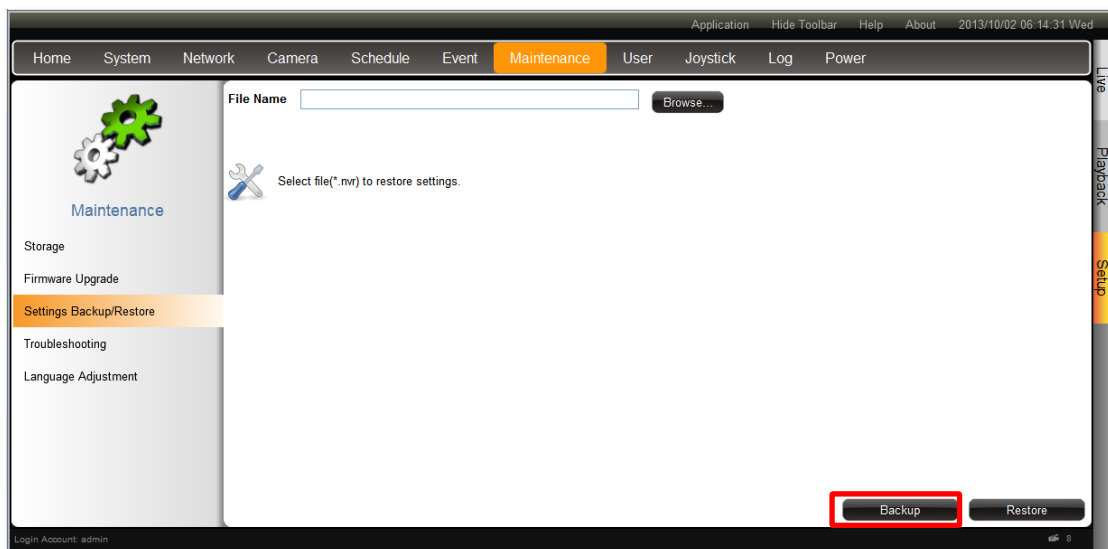

2. Click "**Backup**", the backup file will be saved to your client computer as .nvr file.



## Restore

Before starting restoring the system, make sure you have connected the USB disk with the desired .nvr backup file in it, and the backup file is saved in the root directory.

1. Go to **Setup** page → **Maintenance** tab → **Settings Backup / Restore**.

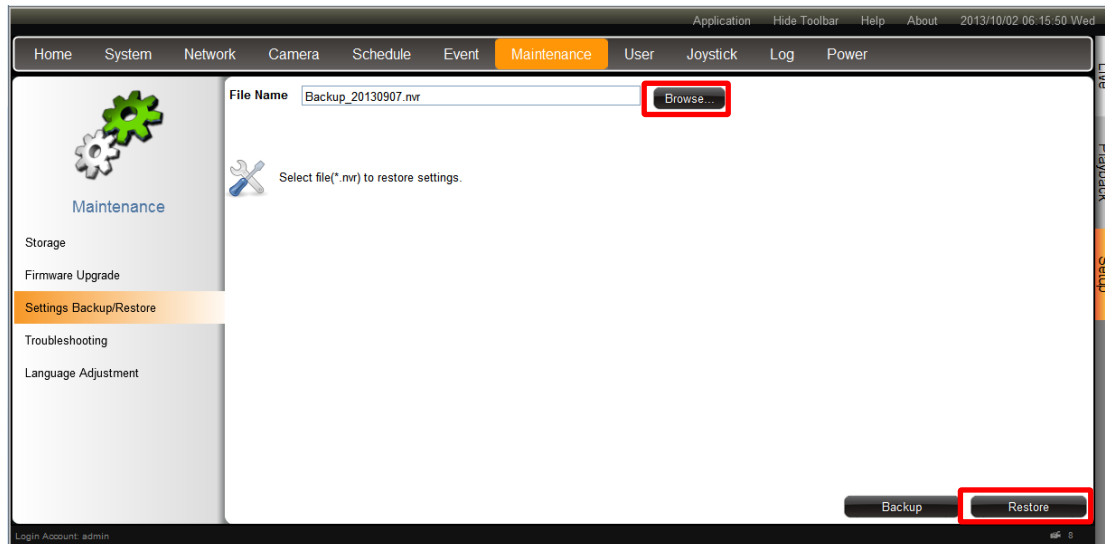

2. Click **"Browse"**, find the target \*.nvr file and click **"Open"**.
3. Click **"Restore"** to start restoring the settings.

## User Group Management

In ENR, the access permissions are managed by **User Groups**. **User Groups** defines what functions are allowed for a group of users. Different **User Groups** will have different access rights in terms of permitted operations like monitoring **Live** screen or execute **Playback**. For example, an Administrator user is allowed for all the operations in ENR, while a standard normal user may only be permitted to do **Live** monitoring.

Go to **Setup** page → **User** tab.

### Add a Group

By default, the **Administrator** User Group with full permissions in ENR already exists. Except for the password and e-mail settings, you may not delete this account or change its permissions.

1. Enter **Group**, click “**Add Group**” to bring up **Add New Group** window, enter the **Name** and **Description** of the group, and click “**OK**” to add it to the **Group List**.

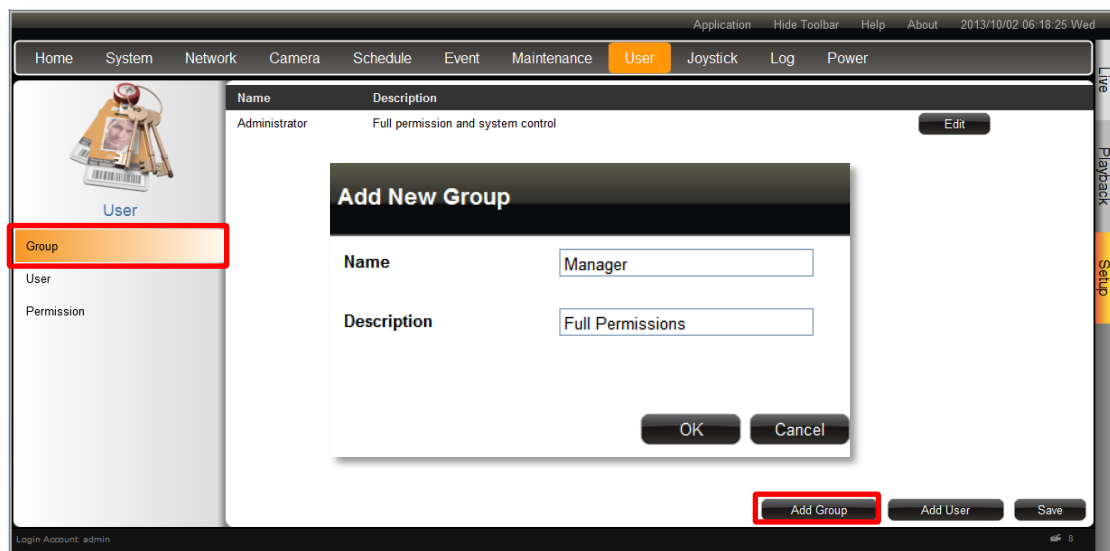

2. Enter **Permission**, and select the group from Group list, enable the permissions possessed by this group.

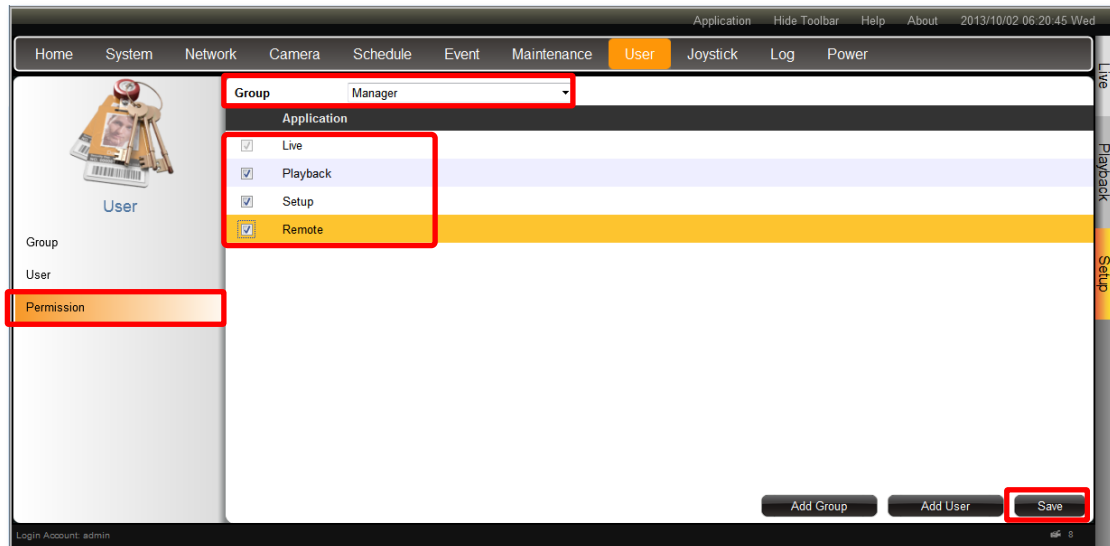

3. Click **“Save”** to save the group settings.

## Edit / Delete a Group

You may edit an existing Group or delete it. Select the user on **Group List**, click **“Edit”** or **Delete”**. Please always click **“Save”** before leaving this page.

Name	Description	
Administrator	Full permission and system control	<input type="button" value="Edit"/>
Manager	Full Control	<input type="button" value="Edit"/> <input type="button" value="Delete"/>

## Add a User

By default, the **Administrator** User already exists, which you may not delete.

Go to **Setup** page → **User** tab.

1. Enter **User**, click “**Add User**” to bring up **Add New User** window, enter the **Name** and **Password**, and select its **User Group**, click “**OK**” to add it to the **User List**.

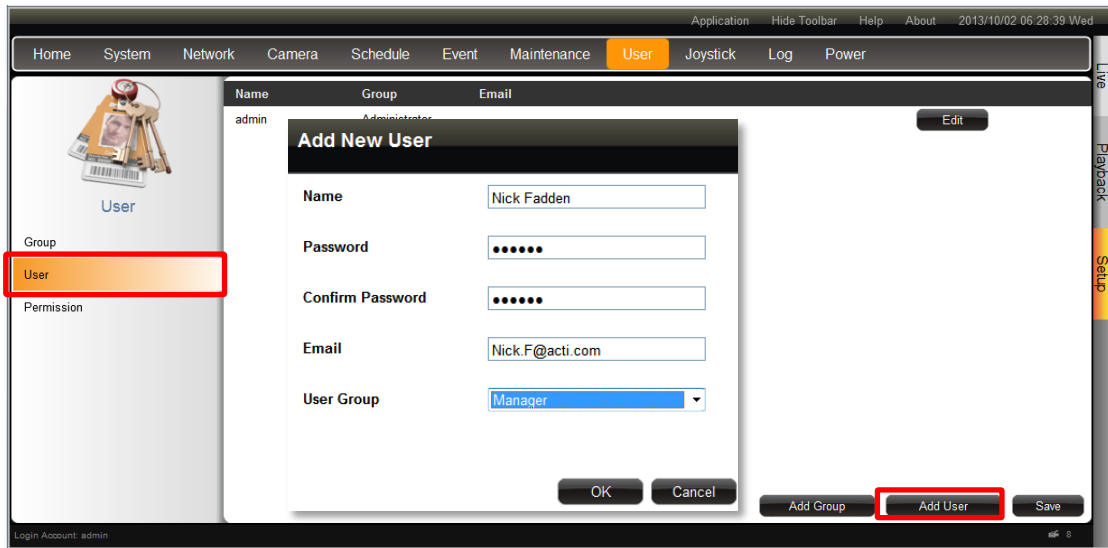

## Account /Password Rules

1. **Account** field allows alphabets, numbers, and symbols except the following: \* < > ? | " \ : .  
The maximum length of characters is 15.
2. **Password** field allows alphabets, numbers and symbols. The maximum length of characters is 40.
3. Both the **Account** and **Password** field are non-case-sensitive.

## Edit / Delete a User

You may edit an existing user or delete it. Select the user on **User List**, click “**Edit**” or **Delete**”.

Please always click “**Save**” before leaving this page.

Name	Group	Email	
admin	Administrator		Edit
Nick Fadden	Manager	Nick.F@acti.com	Edit Delete



## Joystick

ENR supports two types of controller for remote client operations:

- **IP Desktop**, manufactured by **CH Products**
- **Extreme™ 3D Pro**, manufactured by **Logitech**

1. Connect the joystick to your client computer, and install its driver.
2. Log in to ENR, and go to **Setup** page → **Joystick** tab.

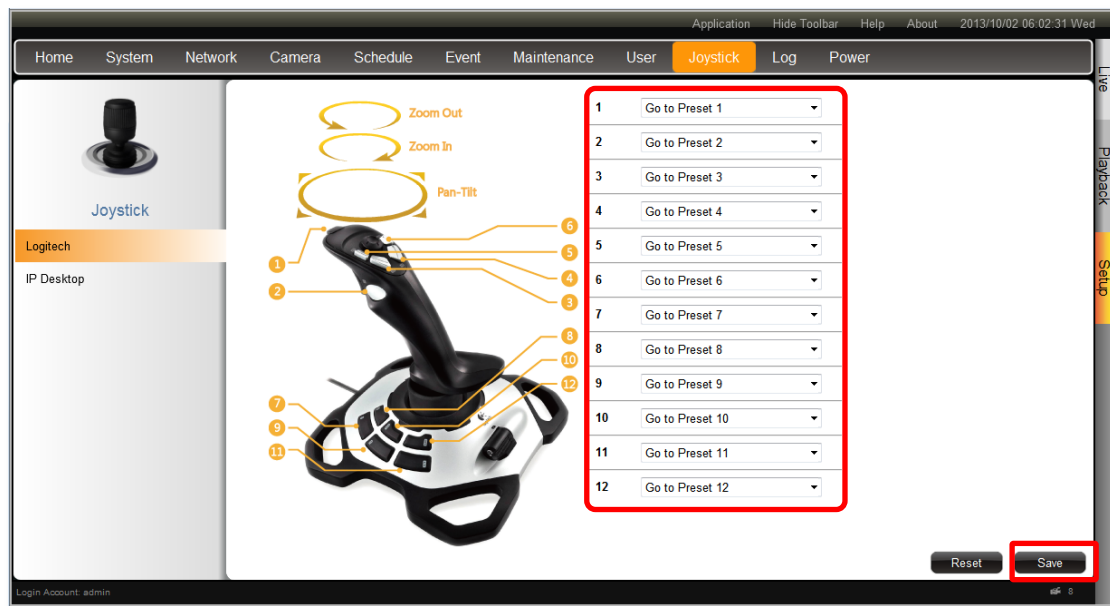

3. There are **12** buttons available on each controller; you may assign a function selected from dropdown list to any button. Every time you change the settings on this page, please click "**Save**" to save the settings of this joystick model.

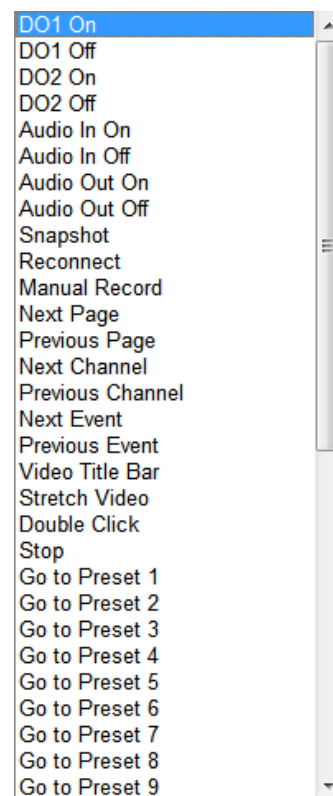

## System Log

ENR records the important system activities and user's behaviors in **System Log**. Once the number of logs exceed 3000, ENR will erase the earliest 100 logs.

Go to **Setup** page → **Log** tab.

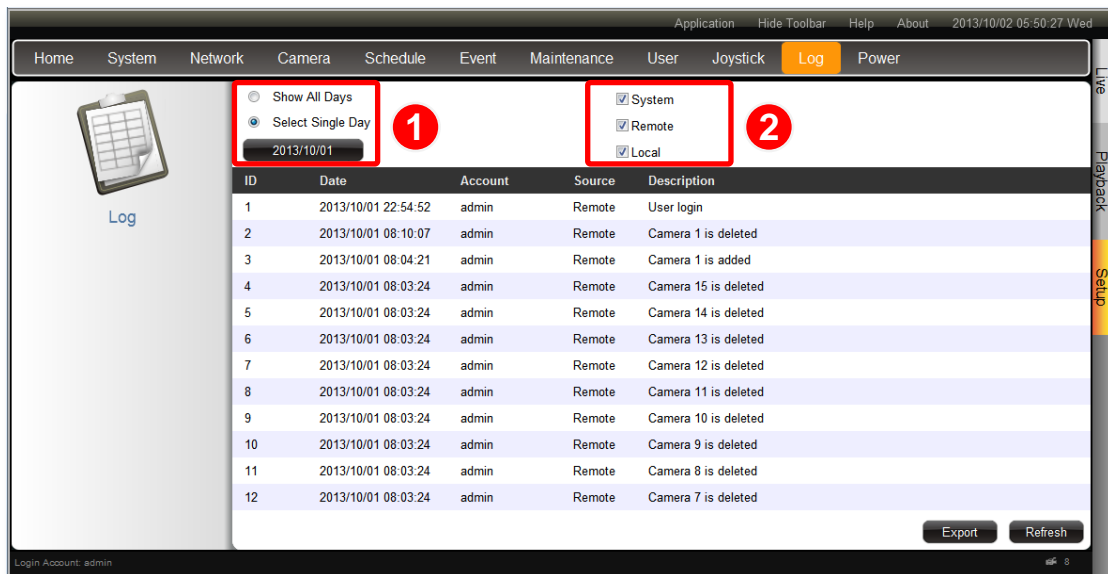

1. Define the time range:  
You may choose “**Show All Days**” to show all the logs or choose “**Select Single Day**” then click **Date** button **2013/09/07** to define a specific date.
2. Select **Log** types:

Log Types	Event
<b>System</b>	System start up, format storage
<b>Local User Behaviors</b>	Login & logout, add camera, reboot / shutdown system, modify event settings, upgrade firmware , format storage, backup / restore system configuration, modify schedule settings, modify time, modify e-mail server settings, modify system information, modify network settings, modify user & permissions, import language file
<b>Remote User Behaviors</b>	Login & logout, reboot / shutdown system, modify camera settings, modify event handling schedule/settings, upgrade firmware, format storage, backup / restore system configuration, modify recording schedule, modify time, modify e-mail server settings, modify system information, modify network settings, modify user &permissions, import language file, modify workspace parameter

By changing the criteria, the result will automatically refresh accordingly.

## Export System Log

To export the logs, click “**Export**” and save the xml file to your local computer. You may view this file with **Notepad** or **XML Editor**.

```
<?xml version="1.0"?>
- <Logs>
  <Log Source="Local" Account="admin" Date="2013/09/07 04:51:08" ID="1">Camera 9 is added</Log>
  <Log Source="Local" Account="admin" Date="2013/09/07 04:50:05" ID="2">Camera 9 is deleted</Log>
  <Log Source="Local" Account="admin" Date="2013/09/07 04:49:50" ID="3">Camera 9 is added</Log>
  <Log Source="Local" Account="admin" Date="2013/09/07 04:49:50" ID="4">Camera 3 is added</Log>
  <Log Source="Local" Account="admin" Date="2013/09/07 04:48:01" ID="5">Camera 9 is deleted</Log>
  <Log Source="Local" Account="admin" Date="2013/09/07 04:47:54" ID="6">Camera 3 is deleted</Log>
  <Log Source="Local" Account="admin" Date="2013/09/07 04:43:40" ID="7">Backup system configuration</Log>
  <Log Source="Local" Account="admin" Date="2013/09/07 00:48:40" ID="8">User login</Log>
  <Log Source="System" Account="*" Date="2013/09/07 00:44:13" ID="9">System start up</Log>
</Logs>
```

## Customize Live Screen Layout

You may customize the layout style, channel position and patrol behavior. Your arrangement of **Live** screen layout will be the default view after any local user logs in to ENR.

### Change Layout

(A) To change current view layout, select your desired layout by clicking on a **Layout Selection Button**.

### Add Camera Views to Channels

(B) To immediately see all the camera views, double-click on “**All Channels**”. The live view will change to the layout with the maximum channels.

(C) You may drag any camera from **Camera** list into your desire channel to display its view.

### Remove Camera Views

(D) To remove a camera view from a channel, right-click on the channel to bring up **Channel Menu** and click “**Disconnect**”.

(E) To remove all camera views at a time, click “**Application**” on title bar and then “**Disconnect All Channels**”.

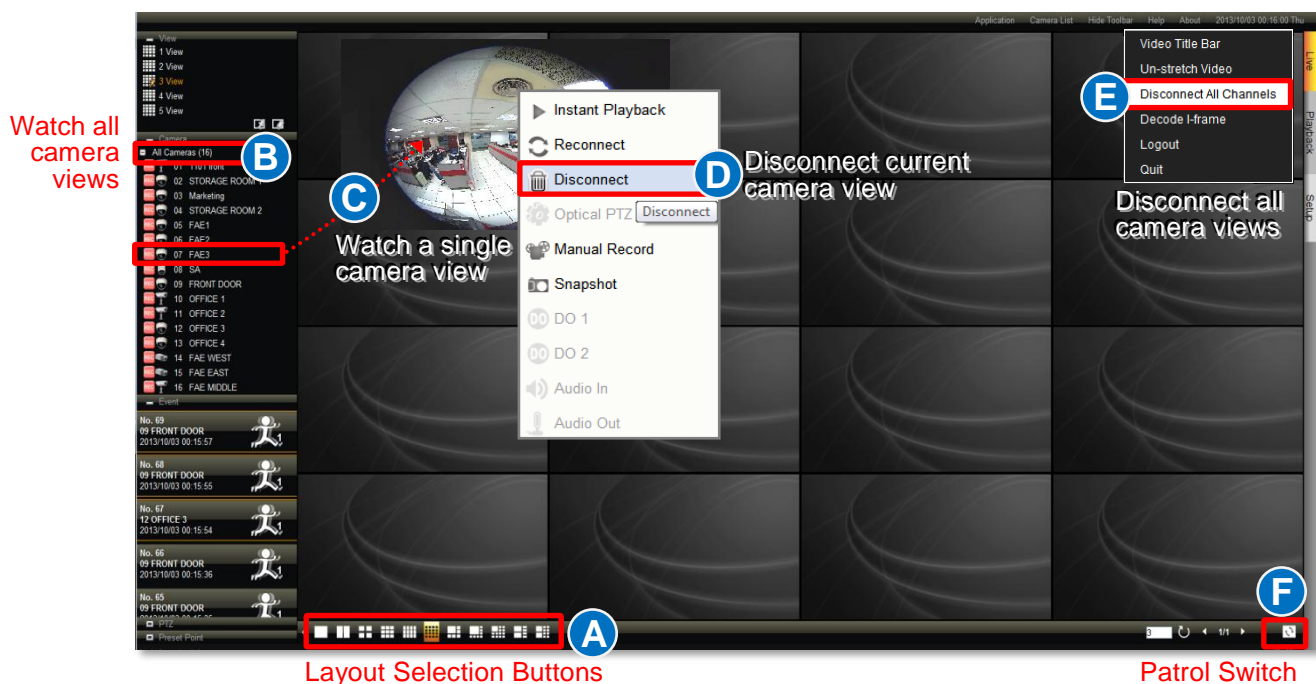

(F) Push the current view to local live view. By doing this, a new local customized view will be created to display this view. Please make sure there is no blank channel in your current remote live view.



## Execute Sequence Patrol

The patrol function will slide-show multiple channels at your defined length of interval. At one time the layout will show as many channels as its maximum display channels. For instance, during the patrol, a 3x3 layout will show channel 1~9, and then 10~16.



1. On **Live** screen, input the duration of each view next to  .
2. Click  to start the patrol.
3. The patrol will go on until you click it again.

## Save a Customized View

You may save up to five customized view on local **View List**. A saved view will remember (1) the layout style, (2) camera arrangement, (3) view size (stretched / un-stretched / full-screen)

1. Select a View from the **View List**.
2. Customize your layout with the tools provided on **Layout Selection Buttons**.
3. Click  in bottom right corner of **View List** to enter Save View window, input the view name and click “**Save**”.

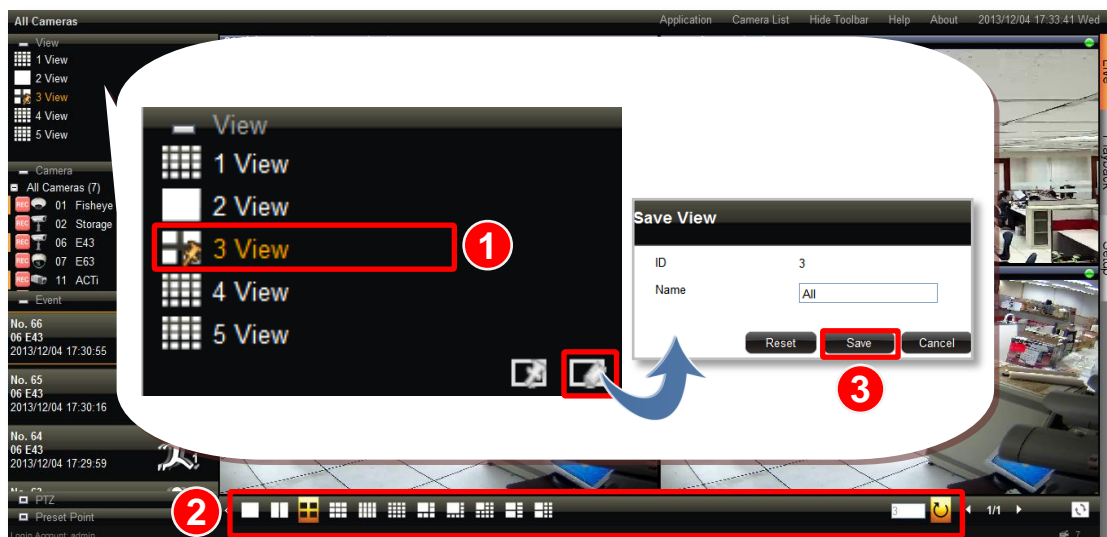

## Set a Default View

You may also set one View as default, in this way, you may immediately start live monitoring after logging in to the system. To set a default view, simply select a desired view on **View** list, and click

